



ELSEVIER

GfÖ

GfÖ Ecological Society of Germany,
Austria and Switzerland

Basic and Applied Ecology 59 (2022) 105–138

Basic and
Applied Ecology

www.elsevier.com/locate/baae

PERSPECTIVE PAPER

Towards a multisensor station for automated biodiversity monitoring



J. Wolfgang Wägele^{a,*}, Paul Bodesheim^b, Sarah J. Bourlat^a, Joachim Denzler^b, Michael Diepenbroek^c, Vera Fonseca^{a,d}, Karl-Heinz Frommolt^e, Matthias F. Geiger^a, Birgit Gemeinholzer^f, Frank Oliver Glöckner^g, Timm Haucke^h, Ameli Kirse^a, Alexander Kölpinⁱ, Ivaylo Kostadinov^j, Hjalmar S. Kühl^k, Frank Kurth^l, Mario Lasseck^e, Sascha Liedke^m, Florian Loschⁿ, Sandra Müller^o, Natalia Petrovskaya^p, Krzysztof Piotrowski^q, Bernd Radig^r, Christoph Scherber^a, Lukas Schoppmannⁱ, Jan Schulz^s, Volker Steinhage^h, Georg F. Tschan^a, Wolfgang Vautz^m, Domenico Velotto^c, Maximilian Weigendⁿ, Stefan Wildermann^t

^aLeibniz-Institut zur Analyse des Biodiversitätswandels, Adenauerallee 160, 53113 Bonn, Germany

^bComputer Vision Group, Faculty of Mathematics and Computer Science, Friedrich Schiller University, Ernst-Abbe Platz 2, 07743 Jena, Germany

^cMARUM – Center for Marine Environmental Sciences, University of Bremen, 28359 Bremen, Germany

^dCentre for Environment, Fisheries and Aquaculture Science (Cefas), Barrack Road, The Nothe, Weymouth, Dorset, DT4 8UB, United Kingdom of Great Britain and Northern Ireland United Kingdom

^eMuseum für Naturkunde – Leibniz Institute for Evolution and Biodiversity Science, Invalidenstraße 43, 10115 Berlin, Germany

^fUniversität Kassel, AG Botanik, Heinrich-Plett-Str. 40; 34132 Kassel, Germany

^gAlfred Wegener Institute, Am Handelshafen 12, 27570 Bremerhaven, Germany

^hIntelligent Vision Systems Group, Department of Computer Science, Bonn University, Endenicher Allee 19A, 53115 Bonn, Germany

ⁱTechnische Universität Hamburg, Institut für Hochfrequenztechnik, Denickestraße 22, 21073 Hamburg, Germany

^jMax-Planck Institute for Marine Microbiology, Celsiusstr. 1, 28359 Bremen, Germany

^kGerman Center for Integrative Biodiversity Research (iDiv) Germany

^lFraunhofer-Institut für Kommunikation, Informationsverarbeitung und Ergonomie (FKIE), Fraunhoferstr. 20, 53343 Wachtberg, Germany

^mION-GAS GmbH, Konrad-Adenauer-Allee 11, 44263, Dortmund, Germany

ⁿNees-Institut für Biodiversität der Pflanzen, Universität Bonn, Meckenheimer Allee 171, 53115 Bonn, Germany

^oUniversity of Freiburg, Faculty of Biology, Geobotany, Schaenzlestr. 1, D-79104 Freiburg, Germany

^pSchool of Mathematics, Watson Building, University of Birmingham, Birmingham B15 2TT, United Kingdom

^qIHP – Leibniz Institute for High Performance Microelectronics, Im Technologiepark 25, 15236 Frankfurt (Oder), Germany

^rDepartment of Computer Science, Boltzmannstrasse 3, 85748 Garching, Germany

^sInstitut für Chemie und Biologie des Meeres Universität Oldenburg, Postfach 2503, 26111 Oldenburg, Germany

^tInformatik 12, Friedrich-Alexander-Universität Erlangen-Nürnberg, Cauerstr. 11, 91058 Erlangen, Germany

Received 28 June 2021; accepted 5 January 2022

Available online 7 January 2022

*Corresponding author.

E-mail address: w.waegle@leibniz-zfmk.de (J.W. Wägele).

<https://doi.org/10.1016/j.baae.2022.01.003>

1439-1791/© 2022 Published by Elsevier GmbH on behalf of Gesellschaft für Ökologie. This is an open access article under the CC BY-NC-ND license (<http://creativecommons.org/licenses/by-nc-nd/4.0/>)

Abstract

Rapid changes of the biosphere observed in recent years are caused by both small and large scale drivers, like shifts in temperature, transformations in land-use, or changes in the energy budget of systems. While the latter processes are easily quantifiable, documentation of the loss of biodiversity and community structure is more difficult. Changes in organismal abundance and diversity are barely documented. Censuses of species are usually fragmentary and inferred by often spatially, temporally and ecologically unsatisfactory simple species lists for individual study sites. Thus, detrimental global processes and their drivers often remain unrevealed. A major impediment to monitoring species diversity is the lack of human taxonomic expertise that is implicitly required for large-scale and fine-grained assessments. Another is the large amount of personnel and associated costs needed to cover large scales, or the inaccessibility of remote but nonetheless affected areas.

To overcome these limitations we propose a network of Automated Multisensor stations for Monitoring of species Diversity (AMMODs) to pave the way for a new generation of biodiversity assessment centers. This network combines cutting-edge technologies with biodiversity informatics and expert systems that conserve expert knowledge. Each AMMOD station combines autonomous samplers for insects, pollen and spores, audio recorders for vocalizing animals, sensors for volatile organic compounds emitted by plants (pVOCs) and camera traps for mammals and small invertebrates. AMMODs are largely self-containing and have the ability to pre-process data (e.g. for noise filtering) prior to transmission to receiver stations for storage, integration and analyses. Installation on sites that are difficult to access require a sophisticated and challenging system design with optimum balance between power requirements, bandwidth for data transmission, required service, and operation under all environmental conditions for years. An important prerequisite for automated species identification are databases of DNA barcodes, animal sounds, for pVOCs, and images used as training data for automated species identification. AMMOD stations thus become a key component to advance the field of biodiversity monitoring for research and policy by delivering biodiversity data at an unprecedented spatial and temporal resolution.

© 2022 Published by Elsevier GmbH on behalf of Gesellschaft für Ökologie. This is an open access article under the CC BY-NC-ND license (<http://creativecommons.org/licenses/by-nc-nd/4.0/>)

Keywords: Biodiversity monitoring; AMMOD; Bioacoustic monitoring; Visual monitoring; Computer vision; Metabarcoding; Volatile organic compounds; Pattern recognition; Computer science; Artificial intelligence

Introduction

Biodiversity is one of the most valuable resources of our planet. An estimated 10+ Million extant species and most of these still unknown to science (Mora et al., 2011; Locey & Lennon, 2016), the biosphere of our planet could guarantee future generations a wealth of hitherto untapped genetic resources, which are relevant to food production, medicine, bioenergy production, and life-supporting ecosystem functions. Overshadowed by global climate change, the global biodiversity crisis is often overlooked, but the steady loss of biodiversity is irreversible and leads to an impoverished world (Ehrlich & Pringle, 2008; Dirzo et al., 2014) that will not recover its species richness within the next 5 million years (e.g. Benton & Harper, 2009). Also, the same species will never evolve again, after regeneration the biological world will be different.

More than 20 years ago, large-scale destruction of habitats and loss of biodiversity alarmed researchers and policy makers (Ripple et al., 2017). Goals to protect biodiversity were defined by the *Convention on Biological Diversity* (1992). The 2010 goals of the European Parliament, later renewed for 2020, had little effect (e.g. van Swaay et al., 2013), although being integral parts of several framework directives and related issues (Biodiversity Strategy, Water Framework

Directive, Marine Strategy Framework Directive). One important reason for the implementation failure is the lack of reliable high-resolution, large-scale and long-term biodiversity data (Mihoub et al., 2017). In analogy to climate research, such data are needed as a basis for making informed decisions, to analyze causes of local extinctions, to provide evidence for trends, to model scenarios that explain changes and for prediction of future processes, and to assess the effectiveness of conservation interventions and their usefulness based on scientific data.

It is a fact that the disappearance of a large part of the insect fauna in Central Europe (Hallmann et al., 2017) was not discovered for many years despite the efforts of public nature conservation institutions to document the state of biodiversity. Taxon specialists have been observing the dwindling numbers of single taxa (e.g. Laussmann et al., 2009; Van Dyck et al., 2009; Schuch et al., 2012; Brooks et al., 2012; Goulson et al., 2015), however, until 2017 it was not obvious that all flying insects are affected. A comprehensive monitoring of insects did not exist and until now it has not been established. In general, for several years now scientists have been calling for a broad, institutionalized, cooperative and systematic monitoring of habitats and populations (Balmford, Green & Jenkins, 2003; Field et al., 2007; Hausmann et al., 2020).

Unfortunately, there are six major obstacles impeding biodiversity monitoring at species level: 1) the difficulty of species identification (the “taxonomic impediment”), 2) the scale problem (species numbers vary with the size of the area considered), 3) the reference problem (species numbers can be compared for the same type of habitat, between regions, between time periods), 4) the workload: automated workflows have not been developed, 5) the lack of quality-controlled open-access data systems for monitoring and 6) the lack of baseline reference data (for the situation before biodiversity deterioration started) (Mihoub et al., 2017).

The workload implies high costs (e.g. Gardner et al., 2008) and forces ecologists to select indicator taxa and representative sampling sites (e.g. Herzog et al., 2016). However, the most significant obstacle is the taxonomic impediment. Even when sampling campaigns are well planned and executed, the samples have limited value if the majority of species cannot be identified. This difficulty is mainly due to the fact that taxonomists are scarce and specialized for selected taxa. Furthermore, the sorting and curation of samples requires time and resources. Describing the regional diversity only for a few taxa (e.g. bees) or limiting identifications to higher taxa (e.g. “Chironomidae”) is insufficient because even closely related species can react differently to environmental changes, species diversity differences between localities would remain undetected, negative trends of single species will be overlooked, and the presence of species new to science might remain undetected (e.g. Bonmarco et al., 2012; Ekrem, Willassen & Stur, 2007; Elbrecht et al., 2016; Homburg et al., 2019; Janzen et al., 2009; Köhler et al., 2005; Schuch et al., 2012; Smith et al., 2006).

Large-scale and long-term automated monitoring of biodiversity (as established for climate research) does not exist, among other reasons, because the required technology is not currently available, yet. It is therefore crucial to adapt existing technologies for the development of automated, reliable, and verifiable biodiversity monitoring. Similar to climate research, we need “weather stations for species monitoring” in addition to remote sensing.

We do not discuss here optimized monitoring schemes or approaches that include volunteers, ecological experiments, or the search for drivers. Our focus is tools that facilitate autonomous biodiversity monitoring. It is possible to construct automatized multisensor stations for monitoring species diversity (AMMODs) using available technologies. These technologies include bioacoustic sensors, tailored imaging systems, automated image analysis, DNA-barcoding, analyses of volatile organic compounds (VOCs) and discriminators to distinguish specimens by their inherent characteristics (such as movement and velocity) using artificial intelligence approaches or multivariate discriminators. Thus, it is possible to detect simultaneously and with high temporal resolution various classes of organisms present in a locality.

In addition to species detection, the recording of behavior, metadata such as ambient environmental parameters and

abiotic factors are important variables to be correlated with spatio-temporal species occurrence. The on-site temperature regime, precipitation, wind force and direction, hydrographic situation or information on the directional movement add significant eco-taxonomical context to individual recordings and their interpretation.

The AMMOD stations allow the continuous detection of a large range of terrestrial meso- and macrofaunal species and environmental parameters and deliver consistent and standardized data as required in monitoring and environmental research (Lombard et al., 2019). The main challenges are (1) in the field of computer science (pattern recognition, change detection, motion sensors and comparison of environmental signals with reference databases), (2) the completion of reference and training datasets (also for little known taxa), (3) the improvement and integration of existing sensors and hardware solutions, (4) the adaptation of sensors to target species (e.g. large vs. small mammals), and (5) in the assembly, testing, and long-term operation of a network of AMMODs (Fig. 1). For the interpretation of large monitoring data sets we also need databases with species-specific trait data, ideally as international databases with the possibility to select the properties of regional faunas.

Technologies for biodiversity monitoring

Due to the increasing demand for data on trends in the biosphere, interest in the automation of biodiversity monitoring awoke in recent years. **DNA-barcoding** was first identified by Paul Hebert, Ratnasingham and Dewaard (2003) as a tool for rapid automated species identification. Some years later it became obvious that in combination with mass-sequencing technologies DNA-barcoding can be used to analyze pooled mass-samples of e.g. insects or DNA from environmental samples (**metabarcoding**; e.g. Thomsen et al., 2011; Takahara et al., 2012; D. W. Yu et al., 2012; Carew et al., 2013; Guardiola et al., 2016; Keck et al., 2017; Majaneva et al., 2018; Giebner et al., 2019). This implies a quantum leap that boosts the analyses of environmental samples. Metabarcoding can reduce labor costs and can deliver data with high taxonomic resolution for all classes of organisms present in a sample (Gibson et al., 2015; Kress, 2017; de Kerdrel et al., 2020; Nkongolo & Narendula-Kotha, 2020). However, expectations must be scaled down, because there are several pitfalls, and standardization of sampling design, of field and laboratory methods is essential to obtain comparable data (e.g. Aylagas et al., 2016; Gossner et al., 2016; Ssymank et al., 2018; Liu et al., 2019; Serrana et al., 2019).

Wührl et al. (2021) designed an interesting **sorting robot** for insects from Malaise samples. It takes images for species identification from insects spread on a tray, and then using a segmented image of the tray, single specimens are pipetted into a 96-well plate for further treatment (e.g. barcoding). This device has the advantage that specimen numbers can

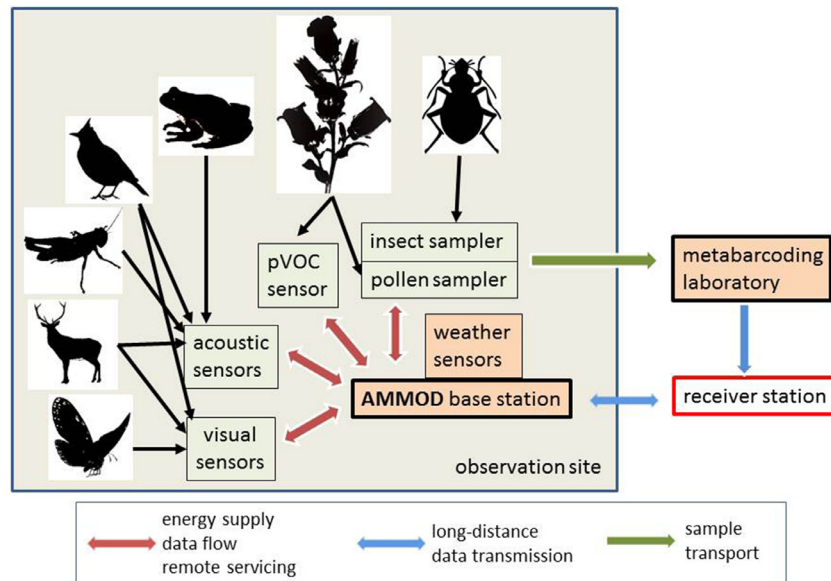

Fig. 1. Illustration of the AMMOD concept. AMMOD stations have a set of different sensors that capture a variety of signals from animal and plant species. Observation sites are connected via internet or radio networks to a receiver station. Some data filtering occurs already in the base station before data transmission. Remote controlling of sensors is included. At the current state of technology, manual intervention is needed to transport samples to metabarcoding laboratories.

be counted automatically per species, and in future it can be useful to add data to barcode reference databases. However, the robot is not suitable for the fast daily treatment of hundreds of Malaise samples as required for large-scale monitoring programs, and it handles only a certain size class of animals.

Image analyses is an obvious choice, because of the impressive development of artificial intelligence and the decreasing costs of digital cameras and data storage. Images can be used for estimates of population densities, body sizes, and behavior. Tools have been developed for wildlife monitoring (usually large mammals) using camera traps (e.g. D. W. Yu et al., 2012; Van Berkel, 2014; Burton et al., 2015; Brust et al., 2017; Steenweg et al., 2017; Iannarilli et al., 2020) and involving volunteers (McShea et al., 2015). For small mammals, Littlewood et al. (2021) attached a camera to a baited tunnel, a method that can replace live-trapping typically used for monitoring of rodents. Bruijning et al. (2018) developed a device for identification of small plankton organisms, Osterloff et al. (2019) observed behavior of deep-water corals with cameras. Other applications have been invented, for example to discover and count pest insects attracted to pheromone traps, yellow pans or bucket traps (e.g. López et al., 2012; Ding & Taylor, 2016). However, until now still most of these devices usually require manual replacement of batteries, data recovery, and time-consuming classification of images. In the future, to overcome these impediments, autonomous systems for object detection can be used (e.g. López et al., 2012; Follmann & Radig, 2018; Bjerger et al., 2021; Delisle et al., 2021; Littlewood et al., 2021).

Standards have been proposed that allow the comparison of data from different projects (Forrester et al., 2016).

Visual classification of insects from mass samples (e.g. Malaise samples) is possible, but requires spreading of specimens on a tray to allow a segmentation software to find individual specimens (e.g. Mele, 2013). For moths this is not necessary when they are observed alive on light traps (e.g. White et al., 2016; Zenker et al., 2016), because the animals sit separately on the screen (though sometimes touching the neighbor: Yao et al., 2013).

EDAPHOLOG (Dombos et al., 2016) is a system consisting of tubes that collect small surface-living and ground-dwelling arthropods that are detected with infrared light and an optical sensor. This allows counting of animals and estimation of their size. A data logger transmits data to a central data station, a web-based control software enables real-time surveillance of system functions. It is possible to discern classes of animals (e.g., morphotypes of mites and collembolans), however, species identification is not possible. The same is true for detection of arthropods using sensor rings with infrared photodiodes (Balla et al., 2020).

A different approach is based on **radar data**. In Australia, remote Insect Monitoring Radars (IMRs) are in use since 1999 (Drake, Wang & Harman, 2002) to detect movement of migrating insects such as locusts, which are a threat for cropping regions. The system incorporates meteorological data and includes data analyses and remote servicing. Stepanian et al. (2020) quantified changes in the annual emergence of mayfly swarms. Radar detection shows the movement and density of insect swarms, but species identification is not possible.

Audio recording devices in combination with semi-automated sound recognition have been used to record the presence and activities of bird species, primates, or insects like crickets (e.g. Schmidt, Riede & Römer, 2011, 2012; Kalan et al., 2015; Buxton et al., 2016; Jahn et al., 2017; Penar, Magiera & Klocek, 2020). Darras et al. (2019) argue that specifically for birds, sound recording surveys are at least as effective as point counts and in addition are more scalable and allow for a higher temporal resolution. describe a combination of hardware and software for an autonomous remote biodiversity monitoring network. Currently, data analyses usually require human intervention, because reference databases for animal sounds are still imperfect and noise filtering still requires additional site-specific background data. This will change when reference databases are more complete.

Radio telemetry is useful for tracking individuals (e.g. Gottwald et al., 2019), but not for diversity monitoring. **Lidar** has been used to detect the backscattering of a laser beam from flying insects at distances between 100 and 300 m and of laser-induced fluorescence (Guan et al., 2010). The latter was only possible because insect specimens were captured and dusted with different fluorescence dyes. The method cannot be used for diversity monitoring. Kirkeby, Wellenreuther and Brydegaard (2016) adapted a lidar system to count and record continuously the activity of flying insects. The system can count individuals and it discerns size classes, but not species. The system is very useful for local monitoring of relative abundance (at the level of size classes of insects) and diurnal activity patterns.

The use of satellite images or LiDAR for the **remote detection** of land-use changes and to discern habitat types as well as the **operation of drones** equipped with multispectral cameras for high-resolution mapping of vegetation (e.g. Pin Koh & Wich, 2012; Paneque-Gálvez et al., 2014) and potentially also insect movement detection (e.g. Kim, Park & Lee 2018; Teickner et al., 2019; Roosjen et al., 2020) are further valuable technologies. However, in the following we will focus on stationary, earthbound systems that can be adapted for AMMOD stations.

The **analysis of volatile organic compounds** emitted by plants (pVOCs) has not been used until now for biodiversity monitoring purposes. However, with suitable detectors pVOCs can provide information on the phenology of plant species and their reaction to climate change and stress.

Tools available to build an automated multisensor station for species diversity

Conventional monitoring methods for species diversity are time-consuming and labor-intensive. The established workflows have advantages (Table 1). However, practical experience of the past decades has proven that data acquisition has always been fragmentary in time, space, and the

taxa considered. As a consequence our current knowledge about biodiversity trends and drivers of change is insufficient for both science and consulting of policy makers.

The advantages of new techniques for automated biodiversity monitoring (Table 2) have been recognized in recent years (Ding & Taylor, 2016; Bohan et al., 2017; Elliopoulos, Potamitis & Rigakis, 2018; Vautz, Hariharan & Weigend 2018; Ärje et al., 2020; Sugai, 2020). Automated devices reduce the expenditure of human labor (Ji et al., 2013; Elbrecht et al., 2017) and local maintenance and allow the control of a network of sensors in landscapes that are difficult to access. Further general advantages are standardization, immediate digitization, independence of subjectivity and experience differences of experts, as demonstrated especially for the application of metabarcoding (Ji et al., 2013). In the case of metabarcoding, usually a larger number of species can be identified (Elbrecht et al., 2017). Most methods allow for detection of unnamed species and later annotation as taxonomic science advances. However, results obtained with such devices depend in the same way as traditional approaches on the quality of sampling designs, spatial placement, taxonomic selectivity of sensors and traps. Furthermore, due to the value of the equipment, prevention of vandalism is an issue. It is self-evident that each sensor type has to be tested for reliability, resolving power and detection range.

DNA barcoding and metabarcoding: state of the art

The shift from the near-exclusive reliance on morphological characters to identifying and detecting species using the DNA barcoding approach (Hebert et al., 2003) represented a major breakthrough in biodiversity studies (Hajibabaei et al., 2012). Assuming a barcode reference library is available, DNA barcoding allows the identification of most species in a fast and standardized way without the necessity to employ many taxonomic experts. The non-availability of experts for species determination is an important impediment in traditional ecological studies. In traditional workflows based on morphological species identification, at least one expert is needed for each taxonomic group (e.g. a family of flies), and up to several dozen are needed for a complex environmental sample (e.g. Kormann et al., 2015). DNA metabarcoding, on the other hand, allows the simultaneous taxonomic identification of organism assemblages from bulk or environmental samples (Fig. 2) using high throughput sequencing of a standardized gene fragment (D.W. Yu et al., 2012), allowing the generation of high quality biodiversity data for all or particular taxonomic groups occurring in an ecosystem, depending on primer choice (Baird & Hajibabaei, 2012).

A 648 bp fragment of the mitochondrial COI gene has become the standard ‘universal’ marker for the Metazoa

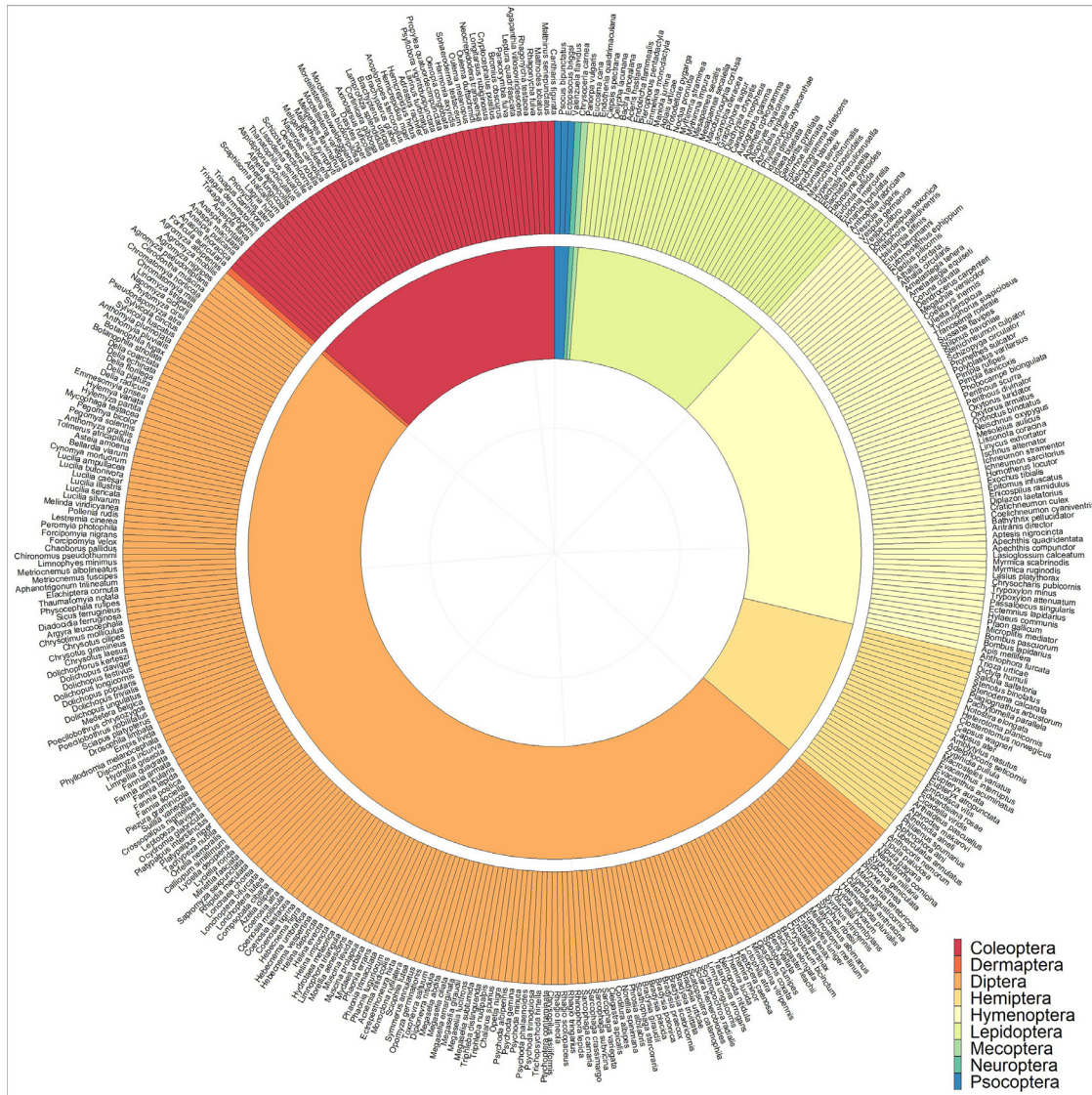

Fig. 2. Example for data obtained by metabarcoding of a single Malaise sample collected within two weeks in West Germany in July 2015. 406 DNA barcodes could be assigned to species represented in the GBOL database, other barcodes obtained from the sample are still unnamed and not considered in this graph. The vast majority of detected insect species are Diptera (orange), which are rarely considered in conventional insect monitoring programs. Other species-rich taxa are Coleoptera (red), Lepidoptera (light green) and Hymenoptera (light yellow).

(Hebert, Ratnasingham & Dewaard, 2003), while the nuclear internal transcribed spacer region (ITS) and the P6-loop of the plastid trnL-F spacer region are the most discriminative plant barcode markers (Kolter & Gemeinholzer, 2020). Today, when taxonomic experts are willing to collaborate with the morphological identification of barcoded voucher specimens, this knowledge can be stored in machine-readable databases (e.g. <https://www.boldsystems.org/>), to allow the automation of species identification. We must stress at this point, taxonomic experts are nevertheless indispensable: for the construction of reference databases, for the compilation of trait data, which are often not documented in the literature, for the biological interpretation of trends observed at species level, and also for teaching.

The analysis of DNA metabarcoding data retrieved from environmental samples relies on a curated barcode reference library, which is constantly updated through the international Barcode of Life (iBOL) initiative and several parallel projects funded by national governments, e.g. Austrian Barcode of Life (Szucsich, 2016), German Barcode of Life (Astrin et al., 2015), Norwegian Barcode of Life (Ekrem et al., 2015). In general, a local or custom-made reference database for the ecosystem and species of interest is recommended, as more species-level matches will be obtained. Metabarcoding datasets are taxonomically comprehensive and quick to produce (Baird et al., 2012; Bik et al., 2012; Taberlet et al., 2012). The technology has proven to be very successful, e.g. for eDNA barcoding of terrestrial,

freshwater, and marine eukaryotes (Floyd et al., 2002; Valentini et al., 2009; Fonseca et al., 2010; Hajibabaei et al., 2011; 2012; Bik et al., 2012; Zhou et al., 2013; Bohmann et al., 2014; Fonseca et al., 2014; Zimmermann et al., 2014), bacteria (e.g. Herrera et al., 2007) and especially for bulk-samples of insects (Moriniere et al., 2016; Creedy, Ng & Vogler., 2019) or of plant traces (Leontidou et al., 2021).

Metabarcoding DNA from Malaise trap catches can document not only the presence of arthropods, but also plants via pollen attached to insects (Bell et al., 2017; Richardson et al., 2015), also allowing the tracking of insect foraging and migrations (Suchan et al., 2019). Mammals can be detected in insect bulk samples through mammalian blood carried by mosquitoes and other parasitic insects (Lynggaard et al., 2019), or through blood-feeding invertebrates such as leeches, that might serve as useful ‘mammal samplers’ (Drinkwater et al., 2019). Metabarcoding has also been suggested as an effective method for the monitoring of invasive species, which would allow the massive scaling up of invasive insect and plant diagnostics (Piper et al., 2019). Another interesting application of DNA-metabarcoding is the monitoring of pollen and spores. Air-borne pollen is traditionally collected with special traps. However, pollen from flowers pollinated by insects is also present in Malaise trap catches and can be detected in the same samples using plant-specific primer pairs (Richardson et al., 2015).

Metabarcoding: challenges

DNA extraction from insect bulk samples is complicated due to the large differences in sizes (typically several orders of magnitude) and abundances of insects present in the Malaise traps. This biomass bias leads to the preferential amplification of large and/or abundant specimens at the expense of small species (Braukmann, 2018). To increase taxon recovery, especially the detection of the smaller taxa, Malaise trap catches can be size-sorted and the size fractions pooled in favor of the smaller size fractions, but this is a rather time-consuming step which is difficult to apply in large-scale monitoring projects. Another desideratum is the determination of abundances from metabarcoding data, as many ecological indices are calculated based on species occurrences, counts and abundances. In metabarcoding, abundances are sometimes linked to read counts, however, the relationship between read counts and biomass or number of individuals is not linear (Lamb et al., 2019).

Metabarcoding of soil and water samples (sequencing environmental DNA) generates evidence for the presence of species, however, the DNA must not necessarily be recent and it could have been transported on particles e.g. by wind or water from a different location. Environmental DNA data are therefore fuzzy.

Due to a number of well-known biases, such as primer bias, biomass bias, sample complexity and copy number all

contributing to differential amplification efficiencies, read counts cannot be directly linked to specimen numbers (Piñol, Senar & Symondson, 2019; Zenker, Specht & Fonseca, 2020). Most often, read counts are converted into a presence-absence matrix, which can be used for measurement of alpha diversity or in case of repeated sampling as indirect abundance measures to detect changes in community composition through time or among sites (Chao et al. 2016). However, relative abundances can sometimes be used for the calculation of ecological indices (Seymour, 2020). In addition, the calculation of calibrations and correction factors has shown great potential for the improvement of abundance estimates from metabarcoding data, however, these might only be applicable to less complex communities, as correction factors would have to be calculated for each species (Thomas, 2016; Krehenwinkel, 2017).

For the automation of specimen counting, devices like particle counters (Kydd, Rajakaruna, Briski et al., 2017) have to be tested for biodiversity monitoring purposes, most likely in combination with an image recognition system (Zhong et al., 2018; Årje et al., 2020), or via multispectral flow cytometry and deep learning for pollen (Dunker et al., 2021). Although those early systems already provide high classifying accuracy results for some species, vision based recognition systems are strongly limited for the detection and classification of cryptic or closely related species showing similar morphological traits. Nevertheless, classifying and counting specimens contained in bulk samples on a higher taxonomic level could provide valuable information for improving and scaling applied-metabarcoding methods (e.g. primer choice). Additionally, vision-based systems can provide biomass estimates (Årje et al., 2020) of present taxa. Obtaining information about biomass of each taxon via image-based identification allows to further adjust applied metabarcoding methods (number of size fractions, pooling ratio of size fractions) while limiting handling time to a minimum. However, due to the large number of samples that should be dealt with, the mere documentation of species presence is very informative for the observation of trends in the development of a local biological community (Ranasinghe et al., 2012; Aylagas, Borja & Rodríguez-Ezpeleta, 2014; Homburg et al., 2019; Bush et al., 2020).

Well-equipped laboratories with liquid-handling robots, large-scale processing protocols, and high throughput sequencing technologies can sequence dozens of environmental samples every day in a cost-effective way. A major remaining challenge is the computing power required for the analysis of the resulting datasets, which typically turns raw sequence data into OTU tables and species lists. Many different software modules and end-to-end bioinformatic analysis pipelines have been developed for these tasks (eg. Qiime2, Boylen et al., 2019) However, sensitivity to the detection of sequencing errors, chimeras, or the clustering algorithms used are strongly variable, making comparability between studies difficult. In addition, the choice of individual data processing steps will vary strongly depending on

the sample type and research question. Metabarcoding data can be processed by clustering the sequences into operational taxonomic units (OTUs) or denoising them into exact sequence variants (ESVs) also termed amplicon sequence variants (ASVs) (Callahan, McMurdie & Holmes, 2017). The advantage of ASVs is that they are reproducible and comparable across studies, as they do not depend on the dataset in which they were created, which is the case for OTUs. Each ASV represents a biological reality which is not bound to the dataset being analyzed. As a result, ASVs can unlike OTUs be used as consistent labels (Callahan, McMurdie & Holmes, 2017), allowing for the direct comparison of studies without having to run a time consuming new analysis.

Furthermore, metabarcoding translates into petabytes of data that need to be stored in centralized or distributed infrastructures. Thus, for routine monitoring using metabarcoding, the challenge in the field of data management is to develop a best-practice workflow to ensure comparability of data along spatiotemporal axes and guarantee long-term storage of big data. A step towards achieving the set objectives is the establishment of a new reference database based on the concept of ASVs. ASVs of studies using primer sets targeting the same gene region are merged in one database. Projects, studies and single samples are automatically compared for the presence and absence of ASVs. Furthermore, each ASV contained in the database is blasted against a well curated taxonomic reference database e.g. BOLD on a regular basis. With this practice also species lists of older studies are extended and completed in time and the databases' quality is continuously increasing. However, due to possible methodological differences between studies downstream analysis must be diligently performed.

Automated sampling for DNA-barcoding

Automated sampling devices can collect organic material transported by wind (like pollen and spores) and catch insects (and their attached pollen). We have built for this purpose a multisampler attached to conventional Malaise traps and to pollen samplers. The programmable devices can be left several weeks in the field without maintenance and can fill for example 12 bottles with insects and tubes for pollen at controlled intervals (Figs. 3, 4). If desired, sampling intervals can also be triggered by temperature thresholds, light and weather conditions. The device is solar-powered and can send information on its functionality to a receiver station.

These robots replace dozens of persons who in traditional monitoring have to go to sampling sites to collect material. The traditional monitoring workflow does not allow standardized long-term sampling simultaneously in many locations. With autonomous sampling robots this is possible.

For monitoring of wind-dispersed pollen, different passive sampling systems exist (Gregory, 1973;

Edmonds, 1979; Giesecke et al., 2010), which need only solar power supply and can be exposed continuously for up to 4 weeks and more (Hofmann, Otto & Wosniok, 2014) (Fig. 4). Volumetric sampling devices are mainly based on the Hirst spore traps (Hirst, 1952; Gregory, 1973; Levetin, Rogers & Hall, 2000; Hofmann, Otto & Wosniok, 2014), which instead of having sheltered vessels with an adhesive slide or foil they are equipped with tubes, suitable for further lab process without additional handling. Sampling efficiencies are generally reported to be high; however, particle size, wind velocity, and type of adhesive all affect sampling efficiency (Levetin, Rogers & Hall., 2000). Other passive pollen and spore collecting devices are available but have a higher sampling efficiency but also air pollution, which may hamper subsequent analysis (e.g. humic acid) (Hofmann, Otto & Wosniok, 2014).

There are still no viable solutions for automated sampling of soil fauna, for insects mining in plant material, fungi (except wind-borne spores), and other difficult cases..

Cameras and computer vision: state of the art

Imaging methods have frequently been used in specimen detection (Schulz et al., 2015; Baschek et al., 2017; Tabak et al., 2019; Bjerge et al., 2021). The application range of such systems not only permits observing terrestrial macroscopic species, such as mammals and birds (O'Connell et al., 2010), but is also useful to monitor arthropods (e.g. leaf-litter arthropods (Collett et al., 2017)), Lepidoptera (McElveen & Meyer, 2020)) or even arboreal species communities (Gregory et al., 2014). These systems generally consist of a lens, a camera, an illumination unit adapted to observation conditions and targets, and a central control to match, e.g., timing, adjust spectral illumination or correct imaging preferences. The design of these components may show a broad variation depending on the specific task and the taxonomic groups in focus. Specific hardware setups for image acquisition is, however, only one component of an automatic visual monitoring system. The huge amounts of captured data increasingly require automated processing in order to localize and count animals in footage and to determine species identity and attributes (e.g. age, sex). Hence, the analysis and evaluation of visual data by a machine is critical.

Endothermic wildlife is usually monitored by camera traps which are triggered by motion detectors (e.g. Burton et al., 2015). For the monitoring of ectothermic species time-lapse mechanisms are needed to trigger camera traps. Camera networks can then cover larger areas and collect data that may give insights into population abundance and temporal trends, demography, species interactions or behavioral patterns. However, partial occlusion due to vegetation, terrain or restricted camera coverage and resulting limited detection probability of animals (individuals that are out-of-focus or out of the view of the camera) require



Fig. 3. Automated Malaise trap: the multisampler unit attached to a Malaise trap has 12 jars for insects and gets its power from a solar panel.



Fig. 4. Autonomous pollen sampler. Left: complete unit; right: the sample collector.

suitable inferential methods to account for incomplete observations. Similarly, automated processing of footage introduces misclassification of species identity, animal locality and counts, which also need to be accounted for in order to provide unbiased estimates. This combined treatment of animal detectability and identification has not yet been well developed for visual, automated monitoring of biodiversity. However, promising approaches do exist, such as for example, in the field of sensor data fusion (Koch, 2016) or specific species monitoring approaches that were previously developed to account for false observations during human-based species surveys. Both humans and machines have in common to occasionally misidentify species and their attributes (e.g. age, sex, behavioral traits). This results in the erroneous recording of false absences or presences or falsely assigned attributes, despite the species being present or absent or having different attributes. A monitoring approach that explicitly accounts for such errors is the occupancy framework (MacKenzie et al., 2017) that can account for both false positive and false negative observations while estimating species site occupancy. Other frameworks for analyzing camera trap data are the random encounter model framework (Lucas et al., 2015) and related approaches (Gilbert et al., 2020), the distance sampling framework (Howe et al., 2017) or capture-recapture techniques (e.g., Royle et al., 2013).

However, they all require extensions to be developed to account for incomplete recognizability of species caused by algorithmic misidentification. Besides conventional camera traps triggered by motion, it is possible to develop specific systems for a particular class or order of animals.

One example is a light trap to attract moths during night. Hence, a moth scanner consists of an illuminated screen and a camera that takes images or films during the dark hours (Fig. 5) Until now, the screening of local moth populations is nearly always done without automated camera systems. Typically, experts spend many night hours watching the moths, counting, collecting interesting specimens, occasionally taking pictures of interesting species. A first attempt for automatic moth monitoring has been proposed by Bjerger et al. (2021). However, their approach requires manual intervention on a frequent basis and the software can so far only handle very few different species. Automated and self-sustaining setups will be developed for AMMOD stations, which allow for standardized data formats that are transmitted to and collected in a central data repository with the aim of monitoring the populations of hundreds of different species. Note that this scales much better compared to manual moth sampling when thinking of a large number of different sites. Furthermore, self-sustaining AMMOD stations with a moth scanner can also be placed at locations in

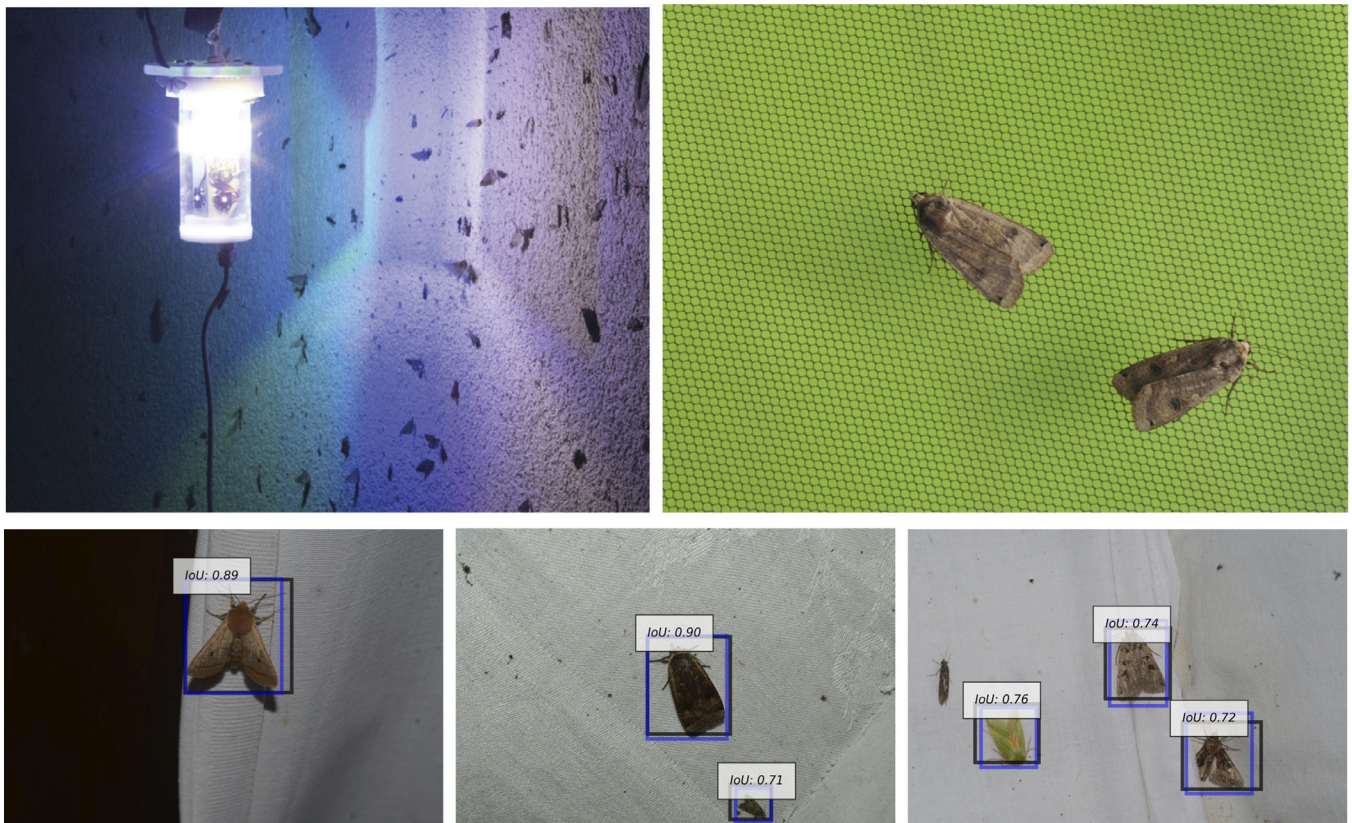

Fig. 5. Elements of a moth scanner. Upper left: screen illuminated by low power LED lamp delivering a mixture of UV and white light (G. Brehm, 2017), right: a typical image of moths attracted by a light trap. Lower row: Example for preprocessed images with automatically detected moths (P. Bodesheim 2021).

the outback that are difficult to reach for field experts on a regular basis and can operate continuously over months without manual interventions.

Visual monitoring: challenges

Smaller organisms require more sophisticated camera setups. With decreasing object size, the field of view (FOV) needs to be reduced to achieve a sufficient magnification for the identification of taxonomic characteristics, this is especially required for moths and tiny insects. However, by narrowing the FOV, the depth of field decreases, a higher susceptibility for motion blurring is observed, and illumination issues become more important (Schulz, 2013). The resulting short shutter times need to be accompanied by strong illuminations or flash units, which again has consequences for the power supply.

Common to camera-based imaging systems is the accumulation of large datasets. Evaluation of thousands of images is labor-intensive and exhausting. Thus, a large-scale biodiversity monitoring system urgently requires reliable high-throughput classifiers for specimen images from different camera setups and a framework to match such data with ecological interactions on relevant scales. Algorithms of computer vision and machine learning are required to handle the massive amount of collected data and to provide accurate species predictions. Hence, this also implies new challenges for developments in computer science, which are tackled by an international research community (see below).

Most of today's impressive results in computer vision and machine learning arise from two major changes during the past 20 years. First, the increased performance of hardware together with the advent of powerful graphical processing units (GPU), and second, the huge amount of (at least partially) annotated image data. In return, citizen scientists can use powerful identification apps at no charge, e.g., flora incognita (Wäldchen & Mäder, 2018; 2019). However, obtaining large collections of annotated images is very important and at the same time challenging in several aspects. First, algorithms of computer vision and machine learning need to be trained with huge amounts of example images to obtain satisfying species recognition accuracies. Second, for automated visual monitoring of biodiversity and to keep track of species presence in a certain region, these example images need to represent the local species occurrence. There exist annotated datasets with images from camera traps located in specific regions around the world (e.g., <http://lila.science/datasets>) but these are useless for monitoring tasks in other areas with a different set of occurring species. Third, such datasets only exist for animals that can be observed with conventional camera traps triggered by motion detectors, but for moths and insects, special camera setups in combination with light traps are required. This leads to a lack of available image data for corresponding species. Last but not least, existing datasets are not machine-

readable and hence require manual intervention for finding and selecting relevant data. This also holds for public archives and networks where image data is often collected by volunteers (e.g., <https://www.inaturalist.org/> and <https://www.gbif.org/>). There, people also contribute example images of species for moths and insects but the amount of available data is usually not sufficient to train accurate classification models. Furthermore, such data samples suffer from a higher chance of wrong species annotations and are often recorded with hand-held cameras, which poses additional challenges for further processing compared to images obtained from mounted camera traps. However, citizen science activities for actively and voluntarily sharing data offers large potentials. It is therefore important to motivate people to share their annotated images of animals, especially moths and insects, or at least to help in collecting such data. A successful example for those activities is again the flora incognita project (Wäldchen & Mäder, 2018; 2019). Although annotated training data is one limiting factor for automated visual monitoring at a certain level of quality, there are several other and equally important challenges from the computer vision and machine learning perspective:

- *Number of species to be distinguished.* Although current computer vision algorithms like the one of Yang, Wu and Chen (2019) can differentiate between up to 11,000 different categories of the ImageNet dataset (Deng et al., 2009), this number is far from being sufficient for the number of species to be expected in a country like Germany (> 60,000 species). Therefore, for the time being, visual systems should be trained for selected taxa or regional faunas, e.g. for a moth scanner applied in Europe that needs to cope with fewer but well-known species compared to a study region in the tropics.
- *Generic classifiers.* Although certain systems already exist for analyzing images of moths, chimpanzees, or other specific classes of objects (Loos & Ernst, 2013; Balfer, Schöler & Steinhage, 2013), those systems have been carefully developed using handcrafted and optimized features and individual domain knowledge. At present, it seems not possible that such specialized systems can be individually developed for all the different classes of animals to be monitored. Thus, there is the need for generic classifiers that learn their feature representation from data, at best in an unsupervised manner (Rodner et al., 2015; Freytag et al., 2016).
- *Fine-grained recognition.* Most computer vision systems for classification of objects in an image are already powerful if it comes to distinction of categories, like cups, cars, dogs, etc. Within-category classification on a species level, i.e., the distinction between a Great Spotted Woodpecker and a Middle Spotted Woodpecker is a much more challenging problem, and currently the focus of fine-grained recognition (Rodner et al., 2015; Korsch, Bodesheim & Denzler, 2019). However, there is still a generic method missing that identifies the relevant, visual parts of objects that allow for reliable classification within a category of morphologically similar species.
- *Detection of the unexpected.* Today's machine learning systems work under the closed-world assumption, i.e., they will map any input image to one of the known classes. Species not known to the system will not be correctly classified, but even worse, might be wrongly assigned to a known class. Thus, methods for novelty and anomaly detection are another big challenge to not miss probably important insights from unexpected observations (Käding et al., 2015; Bodesheim et al., 2013).

- *Keeping the human in the loop.* Today, it cannot be expected that automatic monitoring systems will work from scratch without making any errors. The challenge arising from difficult and changing recording conditions in the wild as well as hiding and only partially visible animals will result in erroneous assignment or even misses of objects present in the image for the human. Thus, acceptance of such systems in the monitoring community will heavily depend on reliability of the automatically generated statistics and properties of the observed species. Consequently, one additional challenge is to provide a feedback mechanism from the machine to the human, to report about uncertain or undetermined results. However, the feedback from the human to the machine is equally important by correcting results or adding additional information for refinement and optimization of the automatic system (Käding et al., 2016b).

In summary, we believe that automatic visual monitoring should be framed in a life-long learning cycle. In Fig. 6a first principle of such a WALI framework (watch, ask, learn, improve), that has been successfully applied to monitor mammals in Portugal (Käding et al., 2016a), is depicted.

The key ingredients are initial generic classifiers, for example, powerful convolutional neural network (CNN) architectures (Lecun, Bengio & Hinton, 2015), active learning to reduce costly annotation effort by experts (Freytag, Rodner & Denzler, 2014; Käding et al., 2015), fine-grained recognition to differentiate between visually very similar species (Simon & Rodner, 2016, Korsch, Bodesheim & Denzler, 2019), and efficient incremental updates of the classifier's model over time (Rodner et al., 2017). For most of these challenges, initial solutions exist. Building first visual monitoring systems, possibly for a restricted area or set of species, will definitely help to improve all parts over time if biodiversity and computer vision researchers are working closely together.

Automated visual monitoring has several limitations, for example where special preparation techniques are required (e.g. material on microscopic slides, dissection of insect parts) or when cryptic species can only be discerned genetically. However, in view of the enormous potential of the use of digitized knowledge, the objective standardization of observations and the upscaling in space and time, the new methods are a huge step forward. And, visual monitoring of e.g. insects is complemented with data from Malaise traps.

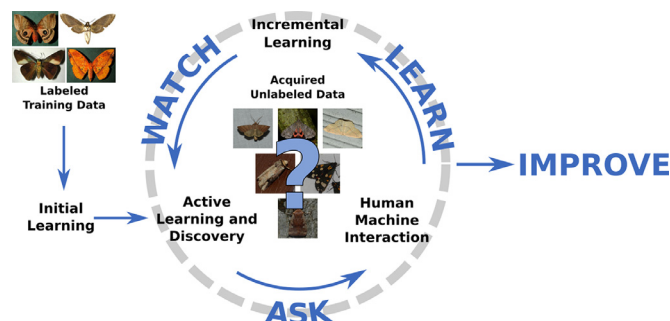

Fig. 6. The WALI concept for life-long learning combining artificial intelligence and human expertise.

Visual monitoring: including depth cues

While camera traps have proven to be an appropriate technique for continuous animal monitoring in an automated 24/7/52 documentation, camera traps including distance measurement are not widely deployed, despite providing valuable additional cues to detect animals, to distinguish individual animals in animal hordes, to locate animals in the observed environment and facilitate the automation of laborious ecological studies like estimating population densities (Howe et al., 2017).

The state-of-the-art approach to the visual detection of individual animals in camera data is the so-called instance segmentation which is a deep learning-based technique to detect and delineate each distinct object of interest appearing in an image or a video clip. This approach is popularized for conventional RGB image and video data by Mask R-CNN (He et al., 2017). Within this AMMOD project, a first instance segmentation approach to the visual detection of individual animals in RGB-D image and video data is proposed by Haucke and Steinhage (2021). This so-called D-Mask R-CNN approach has been applied to RGB-D video clips generated by a low-cost RGB-D camera trap utilizing an Intel® RealSense™ D435 sensor. Applied to these RGB-D video clips, D-Mask R-CNN shows mean average precision scores of 59.94% and 37.27% for deer detection by bounding boxes and segmentation masks, respectively (Fig. 7).

The segmentation masks of detected animals give detailed shape descriptions of the visual appearances of the observed animals and thereby information about their position in the scene and their posture. Tracking this information in camera video clips allows for the derivation and delineation of animal behavior. Schindler and Steinhage (2021) have already shown an automated identification of three action classes (eating, moving, watching) for deer, boars, foxes and hares with detection accuracies between 88.4% and 94.1% in conventional video clips, i.e., without using depth cues. Ongoing work will enhance these results by including depth cues.

Bioacoustic monitoring: state of the art

The development of portable digital audio recorders with constantly growing storage capacities made it possible to

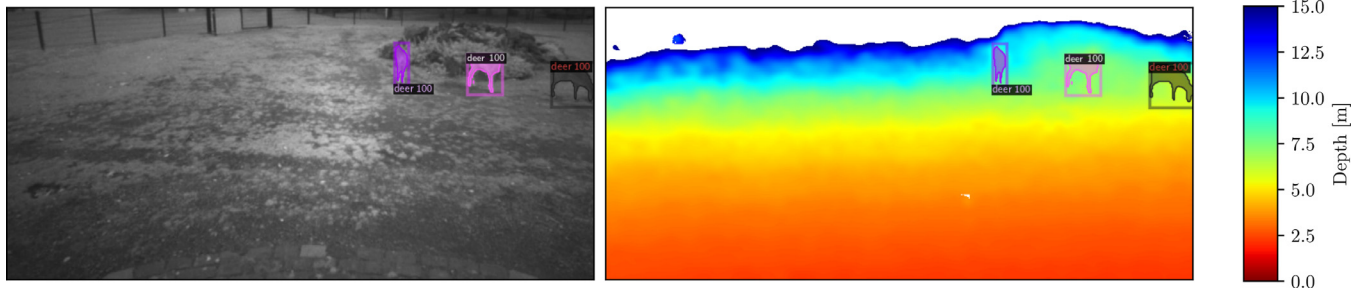

Fig. 7. The use of depth cues in visual monitoring. Left: infrared image with detected animals. Right: color-coded distances (0 to 15 m) help to estimate sizes.

record sounds over long periods of time. The number of papers dealing with terrestrial passive acoustic monitoring increased significantly during the last year, with most studies done on bats followed by birds (Sugai et al., 2019). In most studies autonomous recording units (ARUs) were used. Continuous unsupervised recordings can be made for 7 to 25 days (Darras et al., 2019). The measurement of acoustic activity of bats is already a recognized criterion to assess the collision risks at wind turbines (Willmott, Forcey & Hooton, 2015; Richardson, 2021). Flight calls of birds have been used to study bird migration (Stepanian et al., 2016). In 2017, Australia started a large-scale project, the Australian Acoustic Observatory, comprising 450 listening stations across the country (<https://acousticobservatory.org/>).

While mono or stereo recordings are sufficient to determine species composition, arrays consisting of several microphones allow directional determination and location of calling animals (Rhinehardt et al., 2020). This method has been used e.g. to determine changes in population density of Eurasian Bitterns (Frommolt & Tauchert, 2014).

Nowadays it is easy to collect a large amount of sound recordings. However, it remains a challenge to analyze the huge amount of data. In most cases, an effective species identification relies still on the labor of experts listening to recordings or evaluating sound spectrograms. However, taking into account the expenses for fieldwork, even now acoustic surveys could be more effective than human in situ observations (Darras et al., 2018). Two directions are followed, in order to automatically evaluate long-term audio recordings. For a quick assessment of changes in biodiversity, diverse acoustic indices have been developed (Sueur et al., 2008; Sueur et al., 2014). For reliable species recognition, acoustic pattern recognition methods are applied (Priyadarshani et al., 2018).

Acoustic indices are statistical metrics that are calculated based on one or more aspects of acoustic energy distribution within a recording. So far acoustic indices for α -diversity have been successfully applied in tropical and temperate forests for birds, anurans, and cicadas (Sueur et al., 2008; Farina, Pieretti & Piccioli, 2011; Pieretti, Farina & Morri, 2011; Depraetere et al., 2012; Sueur et al., 2012; Gasc et al., 2013; Gasc et al., 2013). While the correlation between these indices and biodiversity of the singing community is not

always straightforward (Gasc et al. 2015), many case studies show the suitability of these indices to detect ecosystem changes and provide a useful tool for the rapid assessment of long-term acoustic data. For example, acoustic indices have been successfully applied to monitor seasonal and annual variation of the acoustic activity within a habitat, quantities relating also to ecological gradients, land-use and habitat type (e.g. Sueur et al., 2008; Bormpoudakis, Sueur & Pantis, 2013; Gage & Axel, 2014; Fuller et al., 2015; Grant & Samways, 2016). Different acoustic indices express different behavior and highlight different aspects of a soundscape (Towsey et al., 2014; Towsey, Zhang, Cottman-Fields et al., 2014). For example: the acoustic complexity index (ACI) (Pieretti, Farina & Morri, 2011) showed high sensitivity to the dynamics of bird choruses, while an index of acoustic cover (CVR) was most sensitive in response to continuous cicada choruses. The index of temporal Entropy $H[t]$ (Sueur et al., 2008) was specifically designed to pick up infrequent night time calls. Combining these indices in “false-color” spectrograms provides a useful tool for monitoring daily, seasonal, and annual trends and relate them to the activity of species (Towsey et al., 2014). In order to exploit acoustic indices for bioacoustic monitoring as set forth in this paper, further research is needed for evaluating indices systematically in different environments and to evaluate their behavior under different levels of background noise. Furthermore, novel deep learning-based classifiers offer the potential for entirely novel acoustic indices that could relate complex acoustic scenes to biologically interpretable properties of the monitored environment.

Algorithms for the automated analysis of animal sound recordings have seen accelerating development in the past decades. Encouraging results have spawned an active field of research (see Priyadarshani, Marsland and Castro (2018) for a recent overview with several new contributions every year, Towsey et al., 2012; Ross & Allen, 2014). An important impulse has also been given by a number of national and international research projects dedicated to this topic (Ganchev et al., 2012; Potamitis et al., 2014; Fagerlund, 2014).

For automated species identification (Fig. 8), deep learning methods based on training artificial neural networks are gaining more and more popularity and increasingly replace

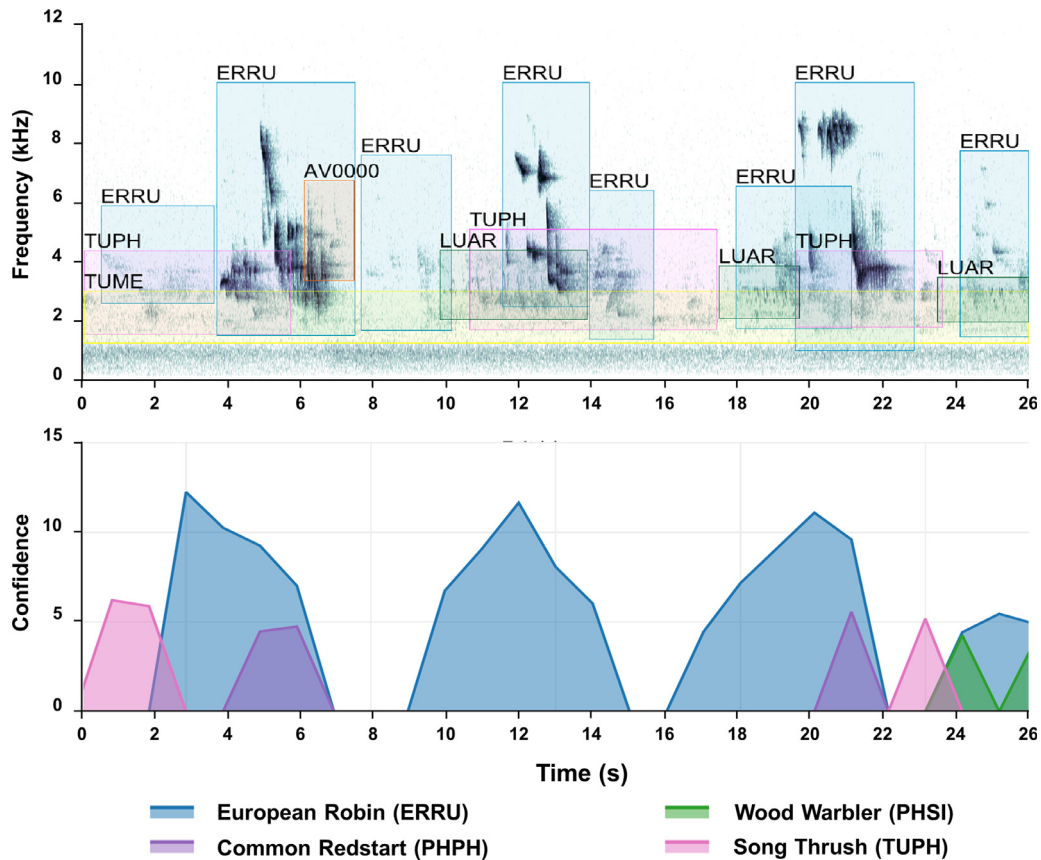

Fig. 8. Automated species identification (BirdCLEF 2019 algorithm) applied to monitoring recordings at the AMMOD location Britz (a forest region near Eberswalde – eastern Germany). Top: Annotation of spectrogram segment. Bottom: Results of acoustic pattern recognition.

conventional well-established pattern recognition and machine learning methods like logistic regression, support vector machines or decision trees (see Priyadarshani et al., 2018 for a good overview on conventional acoustic pattern recognition methods). This trend can be observed following submissions to annual organized large-scale identification challenges like the LifeCLEF bird identification task (Goëau et al., 2018; Kahl et al., 2019) and recent papers published in the field. Currently the most successful approach to identify large numbers of different audio events or individual species in audio recordings is based on training convolutional neural networks on spectrograms, a visual 2-D representation of the acoustic signal. Other, less common methods use a combination of recurrent and convolutional neural networks (e.g. Çakır, 2017) or work directly on raw audio data (e.g. Kong et al., 2019).

Deep learning methods have several advantages over conventional methods. Single models can be trained in an almost end-to-end fashion where features are learned directly from the data rather than being hand-crafted by experts. They also show a significant performance increase if large numbers of species or classes of audio events need to be identified.

When working with multi-channel recordings of complex acoustic scenes, a promising pre-processing approach to further increase identification abilities is to apply sound source

separation and the localization or isolation of individual sound events before classification.

Bioacoustics: challenges

In current bioacoustic monitoring scenarios, as a rule, sound files are stored on memory cards. Remote acoustic monitoring with wireless transmission of acoustic data was up to now realized only in a few cases such as in the PAL-BOA station for underwater sounds (Klink et al., 2016) or the ARBIMON project. Ideally, an automatic recording station would transmit acoustic data continuously, regardless of local conditions. The bottleneck here, however, is the transmission rate in conjunction with mobile telephony, and above all the energy consumption required for recording and transmission. Acoustic recordings also provide information on the density of the animal population (Perez-Granados & Trabaj, 2021). A major challenge, however, is to scale the system so that the results can be compared with traditional counting methods. This requires a standardized microphone arrangement, species-specific recording protocols and, above all, regular calibration of the devices.

Automated analysis of audio recordings is still a major challenge. In particular, the study of complex soundscapes, such as morning birdsongs, is not an easy task, both in terms

of species identification and density assessment. To improve the results of automatic species identification, the development of comprehensive and reliable acoustic reference libraries is essential. A very good basis for this are already existing sound libraries, such as the online library xeno-canto (<https://www.xeno-canto.org>), the Macaulay Library (<https://www.macaulaylibrary.org>), the British Library Wildlife and Environmental Sounds collection (<https://www.bl.uk/collection-guides/wildlife-and-environmental-sounds#>) or the Animal Sound Archive (<https://www.museumfuernaturkunde.berlin/en/science/animal-sound-archive>). Freely accessible reference libraries should contain environmental sounds and annotated soundscapes in addition to specific species recordings.

When using deep learning techniques as state-of-the-art approaches to the bioacoustic pattern recognition tasks at hand, further challenges arise. Among those is the requirement for high amounts of labeled training data. In this, the annotation of complex soundscapes is, however, a very time-consuming task and needs expert knowledge. Another major challenge is the long-tailed distribution of species data, where a few classes have many examples but many classes (e.g. rare species or call types) have very few examples (Van Horn et al., 2017). This can be partially addressed by using various data augmentation techniques to synthetically create more training samples by applying subtle modifications to the original audio recordings or spectrogram images. Data augmentation like e.g. random pitch shifts, time stretching or adding background noise during training can also often help to improve generalization to new data coming from different recording locations or habitats (Lassek, 2019). In spite of those challenges, a suitable combination of machine learning-based acoustic classifiers and established classical mechanisms such as semantic acoustic features or robust acoustic localization is a very promising approach for future research.

In conclusion, bioacoustic information already at this point can provide valuable information in the context of the proposed multisensory station for species diversity.

Automation of animal sound analysis does not completely rule out errors. However, this is also true for manual bird monitoring. Errors occur even when experienced specialists record the data (Mortimer & Greene 2017). The advantage of audio recordings is that errors are documented and can be corrected. Post-sampling quality control is possible and can be implemented in the analysis routine. Another impediment is the short detection range of recorders. This can be compensated using arrays of microphones, which however increases costs.

Analysis of “smellscapes“

A “smellscape” is the sum of volatile organic compounds (VOCs) found in a given locality. The human nose is not very sensitive to odors, nevertheless we can smell the difference between a pine forest and deciduous woodland, a

cornfield and a wildflower meadow, a blooming orchard and an orchard with ripe apples. The high sensitivity of technical VOC detectors can make use of these differences and translate them into an automated monitoring system for plant phenology and diversity, at the same time detecting potentially relevant volatiles from other sources such as animals or pollutants.

pVOC monitoring: state of the art

Plants emit a wide range of volatiles, some of which have a clear ecological role, e.g., in pollinator attraction – more than 1700 chemical compounds have been identified from headspace samples of floral scent (Knudsen, Eriksson & Gershenzon, 2006). It has been shown that pVOCs (plant volatile compounds) may play a role in plant-animal or plant-plant communication, they may also play a role against abiotic stress and finally may be the by-product of functionally unrelated physiological processes (Peñuelas & Lluisà, 2015). Overall, the pVOCs emitted by any plant represent a complex phenological proxy of its physiological and ontogenetic condition. From a chemical perspective, it is surprising that a large part of these compounds is attributable to three major classes, based on their biosynthesis. These classes include terpenoids, benzenoids/phenylpropanoids and fatty acid derivatives. Minor classes of pVOC components are represented by nitrogen and sulphur containing compounds or carotene derivatives (Muhlmann et al., 2014).

Two major functional types of pVOC emissions include floral volatiles and vegetative, often stress-induced emissions (Tholl et al., 2006). Especially vegetative emissions are subject to a whole range of biotic or abiotic environmental factors such herbivore attack, radiation, temperature or drought (see Fig. 9) (Dudareva et al., 2006). Phenology, i.e., the seasonal changes in the physiological status of plants, is strongly reflected in the changing emissions of pVOCs (Peñuelas & Staudt, 2010). Plant aromas can contain many individual chemicals, sometimes with very little overlap in the pVOC profiles between even closely related species (Knudsen et al., 1993). Individual components of pVOCs or the overall “bouquet” may thus be taxon-specific, i.e., typical of an individual species, and/or reflecting the physiological or phenological condition of a plant and therefore representing a proxy for its phenology or physiology, respectively.

Scent analysis is an experimental and exploratory research field. “Artificial noses” based on ion mobility spectrometry (Eiceman, Karpas & Hill, 2013) are astonishingly sensitive to minute concentrations of odors. However, until now no attempt has been made to use these technologies for the distinction of, e.g., flowering plants and for monitoring plant phenology in correlation with weather and climate change. These methods will also be useful to detect pesticides and other chemicals potentially harmful to living organisms (Tuovinen, Paakkanen & Hänninen, 2000).

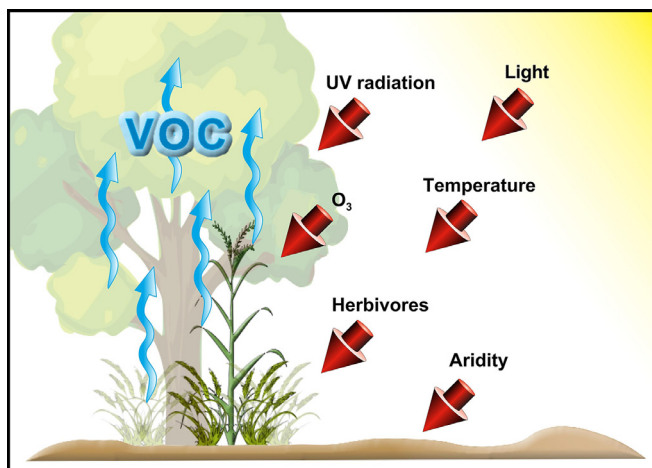

Fig. 9. Environmental factors influencing the emission of volatile organic compounds (VOCs) by plants.

Ion mobility spectrometry (IMS) was developed in the 1970s and its first applications were the detection of chemical warfare agents for military use (Eiceman, Karpas & Hill, 2013). In the following decades, the method was also applied for the detection of drugs and explosives, e.g., at airports.

The method is based on the ionization of gas-phase molecules – most commonly by a radioactive source – and their acceleration in a weak electric field. During the drift to the detector, the ions collide with a counter flow of drift gas molecules, thus resulting in a constant velocity. The measured drift time is normalized to the experimental (drift length and electric field) and ambient conditions (temperature and pressure), thus obtaining the so-called reduced ion mobility after few milliseconds which is characteristic of an individual ion. Furthermore, signal intensity is a proxy for the concentration.

Civilian applications were only developed in the 1990ies, in particular when IMS was coupled with rapid gas-chromatographic pre-separation (GC-IMS). In the ideal case, with this experimental setup the gas-phase molecules enter the ionization region totally separated. An additional measure for the identification of the ions is thus available with their characteristic retention times. In general, identification requires reference measurements using GC/MS to include the substance in a database for a later automatic identification directly from the GC-IMS measurements.

With the combined experimental setup outlined above, even extremely complex samples such as emissions from (bio-)processes (Vautz, Baumbach & Jung, 2006), human breath (Vautz et al., 2009) analysed for medical diagnosis (Pagonas et al., 2012) or for medication control (Perl et al., 2009) or general human metabolites for the detection of trapped victims (Vautz et al., 2013) could also be successfully analyzed. Similarly, it is possible to analyze the volatile metabolites (mVOCs) of bacterial and fungus cultures for their identification (Perl et al., 2011). GC-IMS allows a continuous monitoring of pVOCs with high selectivity and

sensitivity and to record the seasonal variations of “smell-scapes” of particular ecosystems.

pVOC monitoring: first results

First feasibility studies indicate that GC-IMS can discern smells of different plant species (Vautz, Hariharan & Weigend, 2018) under laboratory conditions. Environmental pVOC concentrations are, however, expected to be very low and therefore the particular GC-IMS applied for the AMMOD station is equipped with an in-line chip-based enrichment system, thus enabling quantification of pVOC down to the ppq concentration level (Vautz, Hariharan & Weigend, 2018). Most publications on pVOC emissions are based on headspace analysis in a more or less static setup (Curtis et al., 2014). The set-up applied here has the advantage that measurements can be made quasi-continuously with consecutive sampling periods of 30 min, including automatic data evaluation. This permits a close monitoring of diurnal changes, but will also enable us to detect the correlation of environmental pVOC-patterns with temperature, humidity, radiation and other biotic and abiotic variables.

For the present study, a stationary GC-IMS was installed in March 2021 at the AMMOD pilot station in the Melbgarten in Bonn for continuous monitoring of pVOCs. Furthermore, a second, mobile system (see Fig. 10) is available for e.g., headspace measurements in the laboratory or for measurements directly at the plants in the field.

This technology still has to be validated in the field, but as mentioned above, its potential to identify smell patterns based on the recently implemented reference pVOC database has already been demonstrated. Furthermore, in the framework of the AMMOD project, numerous relevant plants have already been analyzed for their characteristic pVOC profiles. Fig. 11 shows the exemplary pVOC patterns of *Geranium robertianum* (left) and *Urtica dioica* (right). The difference in the particular pVOC pattern with a 4-fold



Fig. 10. The mobile GC-IMS can undertake pVOC-measurements directly on site. The current setup is equipped with rechargeable batteries and an internal, close gas circuit for 4 h of autonomous operation independent of a local energy source..

group of signals in the back of the plot for *Geranium robertianum* and an isolated unique signal in the front of the plot of *Urtica dioica* is clearly visible.

From the measurements of pVOCs as described above, a “smellscape” can be obtained which can be used in the same way as soundscapes to compare plant community diversity and phenology in different localities. Changes in the overall “smellscape” and potentially individual emissions can be monitored with a narrow periodicity,

i.e., permitting the detailed recording of diurnal and seasonal changes.

The structure of the database consists of two compartments. The first part contains data about common compounds (Name, CAS-Nr.), stored together with physicochemical properties and the corresponding metadata. This part also includes data for the particular pVOCs (retention time, relative reduced ion mobility) together with calibration data for later quantifications (Intensity).

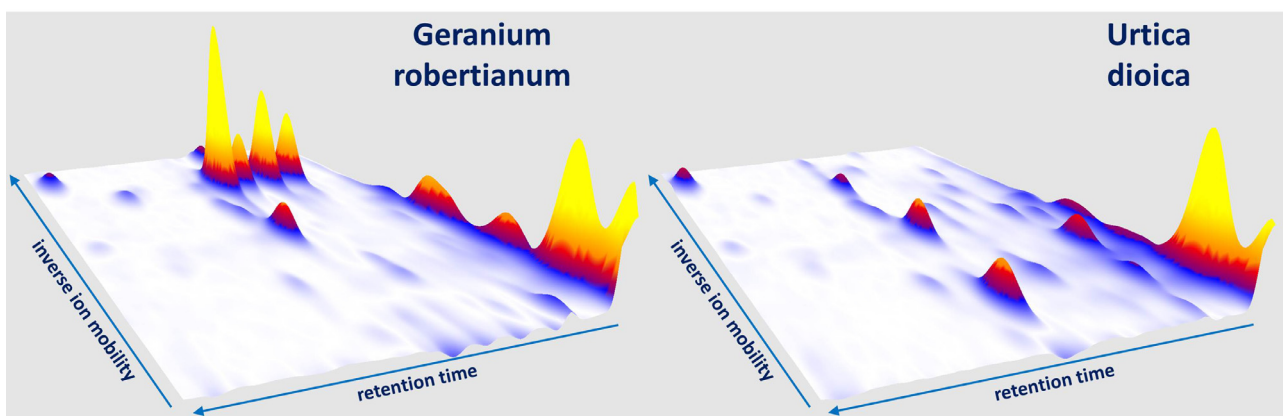

Fig. 11. 3D plot of a complete GC-IMS analysis for two plant species (*Geranium robertianum*, *Urtica dioica*). Dimensions of the graph that characterize detected organic compounds are signal intensity, inverse ion mobility, and retention time.

The second part contains data for plants and their characteristic pVOC emission patterns (retention time, relative reduced ion mobility, relative intensity) in different physiological/phenological conditions. Furthermore, relevant data for the characterization of the plants are stored together with the emission patterns. The investigations can be expanded to seasonal and environmental changes and this complete data set then will be the basis for future trend analyses with regard to characteristic pVOC patterns as well as to anthropogenic influences.

The use of GC-IMS is in an experimental state. It will not be possible to distinguish all plant species, especially when they share volatile compounds with other species or when they are small or rare. Also, as in pollen detection, the method depends on wind direction. However, we expect to see very informative data on phenology and on weather-dependent plant activity. Also, pollen monitoring will provide additional data. In the future, automated drones may add information on vegetation changes at a larger scale.

Sensor technology integration, data collection and data transfer: state of the art

At an observation site, the AMMOD stations for biodiversity monitoring will operate multiple sensor modules, based on the aforementioned sensor technologies. This requires technology to integrate these sensor modules, together with storing, (pre-) processing, and transmitting their data to the AMMOD Data Cloud and the GFBio data archives. This goal will be achieved by designing a generic AMMOD platform, which can be equipped with different sensors and actuators and updated with different software and hardware components. Furthermore, the platform is upgradable for future applications due to the generic concept. It is capable of processing and transmitting potentially huge amounts of data, it will be wirelessly connected and self-sustaining for being easily and flexibly deployable also in harsh environments, either as a stand-alone solution or as a network of communicating sensor nodes.

In the field of environmental and ecosystem research, large-scale projects and environmental monitoring programs such as the National Observation Network (NEON) in the USA (Pennisi, 2010), the Critical Zone Exploration Network (CZEN) (Brantley et al., 2006) or the Terrestrial Environmental Observatoria (TERENO) in Germany (Bogena, Schulz & Vereecken 2006) are known worldwide. These are mostly based on infrastructurally connected measuring stations like they are already known for weather and climate research (example ICOS, <http://www.icos-infrastruktur.de>). Furthermore, the currently deployed environmental monitoring systems are often only partially autonomous. This means that although data are collected autonomously with the help of sensor-logger combinations, the data is mainly stored on intermediate storage on a transportable

storage medium and collected when the user visits the measuring points. As a remedy, wireless sensor networks (WSNs) are increasingly being used, e.g., to monitor abiotic fire and flood detection as well as biotic environmental factors like "Great Duck Island" (Mainwaring et al., 2002) and ZebraNet (Zhang et al., 2004). WSNs have proven to be one of the most effective and versatile methods for collecting data in a variety of applications in extensive terrains (Chang, Hu, King et al., 2004; Porter et al., 2005; Di Francesco, Das & Anastasi, 2011; Matin & Islam, 2012).

However, the AMMOD platform needs to be more flexibly configurable, without relying on available communication infrastructure, and able to operate fully autonomously (for example, also in nature reserves with access prohibition during breeding times), which is why the described existing platforms are only suitable to a limited extent.

Challenges for sensor integration

AMMOD stations need to be based on a generic platform that can be equipped with different sensors and actuators, updated with different software and hardware components, and upgraded for future applications so that it is usable in the biomonitoring domains of the project.

Sensors, particularly from the visual and bioacoustics monitoring, potentially produce huge amounts of data and might have relatively high power demands, depending on the used technology. As a consequence, one major challenge in designing this platform is that, on the one hand, AMMOD stations have to process, store and transmit very large amounts of data via mobile communications. On the other hand, the platform should be self-sustained with only limited resources available in the field—particularly, energy based on solar for a self-sufficient power supply, data storage capacity and communication bandwidth (Fig. 12). For more details on power supply see Appendix A.

Overall, AMMOD stations have to be wirelessly connected and self-sustaining for being easily and flexibly deployable also in harsh environments, either as stand-alone platforms or as a network of communicating sensor nodes.

Approach for multiple sensor integration

AMMOD stations for biodiversity monitoring at one observation site consist of (a) a central base station, which is responsible for the power supply, data handling and data transfer to the AMMOD cloud, as well as (b) multiple sensor modules, as illustrated in Fig. 12. These modules are based on the aforementioned sensor technologies as well as on sensor-specific computing units for reading and to some extent processing sensor data. All sensor modules at one observation site are connected to the base station for aggregating their sensor data and, if required, provide the power supply. As the AMMOD station is self-sustained by making use of

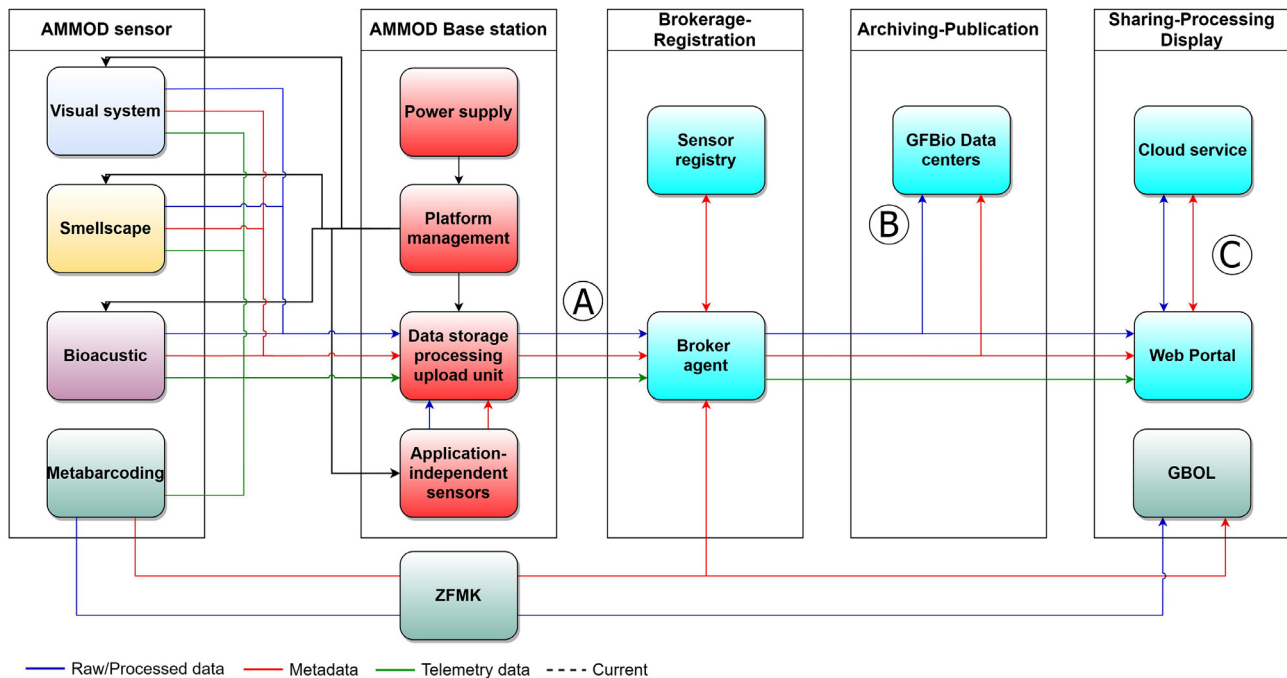

Fig. 12. Graphical representation of the AMMOD hardware and software components and data flow from sensors to the dedicated cloud infrastructure. The data includes unprocessed (raw) and processed measurements (blue lines), descriptive metadata (red lines) and telemetry status data (green lines). GFBio: German Federation for management of biodiversity data; GBOL: German Barcode of Life database; ZFMK: example institute producing DNA barcode data from environmental samples (Zoologisches Forschungsmuseum Alexander Koenig in Bonn, included in the Leibniz Institute for the Analyses of Biodiversity Change).

energy harvesting, the base station is also responsible for energy-aware management of the overall platform. In addition, the base station has to offer status information and to some extent the possibility for remote maintenance and reconfiguration of the complete local sensor network.

Power supply

For remote localities it is essential that AMMOD stations can operate autonomously. Energy supply from solar panels and/or windmills should be reliable and adapt to the diurnal variations of energy consumption and weather conditions in order to prevent sensor blackout and data losses. Data storage, pre-processing, data transmission and remote servicing are further tasks that require energy. To optimize the relation between the dimension (and cost) of the energy supply and its capacity, test runs are necessary to measure energy requirements of a fully equipped AMMOD station under different weather conditions (see Appendix A).

Data transmission

Data transmission from and to the base station covers two aspects. One is the transmission of the sensor data to the base station. The other is the transmission of collected data

from the base station to the database backend. Both aspects require different technologies for their approaches.

For the connection between base station and backend transmissions over a very long range may be necessary. To achieve that a static high-gain antenna configuration can be placed at the base station for a connection to an existing mobile network or to set up a satellite link.

To connect the different sensors to the base station more individual solutions must be devised. Some sensors may be directly attached to the base station allowing for an efficient and reliable high-bandwidth connection. Others may be detached from the base station and not allow for a wired connection. Some low-power low-bandwidth solutions may be applicable here. For other sensors which generate large amounts of data a directional wireless link must be devised that allows high data-throughput without consuming large amounts of energy. To facilitate the modular approach of the base station few efficient but flexible solutions should be devised.

Housing and module integration

Housing suitable for the target environment is another requirement for the autonomy of the AMMOD measurement stations. There are two major aspects that need to be considered here: limiting the influence of the environment on the electronics on one hand, but also limiting the influence of

the installed devices on the environment. Thus, the housing shall protect the equipment against water, temperature, insects and plants, in order to allow reliable functioning of the system. But additionally, the housing shall integrate in the monitored environment to protect it against pollution and other effects that might cause harm or even influence the measurements.

Another aspect that is important from the implementation perspective is the support for modularity and interoperability. If the AMMOD system shall be easily extendable and adaptable, it is necessary that this can be realized without great effort, but simply by adding or exchanging modules or blocks. And for that, it is necessary that the identification, access and connectors between these blocks are manageable also by non-technical personnel.

In the AMMOD project we intend to investigate the options for modularity. We plan to provide a study on the possible options in that area and also on approaches for environment integration.

Data management and archiving

In order to ensure the full autonomy of each AMMOD platform, while preserving the continuous operation of their sensors and the valuable data being generated, proper infrastructure and software components for receiving data from the base stations are needed. Such an infrastructure is responsible for: 1) the data transfer from the base station to a proper data archive for long-term storage and publication; 2) provisioning the data and the metadata in a dedicated cloud platform for pre-processing and analysis; 3) the correct integration of the various AMMOD data types; 4) providing a central registry of sensors and base stations; 5) collecting and provisioning device telemetry data for active network monitoring

Data management: challenges

The main challenge in building an infrastructure with the described capabilities comes from the heterogeneity of biodiversity data produced by the diverse sensors in reconfigurable, spatially-dispersed AMMOD platforms. Although sensors and base stations may be equipped with local hardware storage, scaling up the network, thus increasing the number of platforms to monitor larger areas, will exponentially increase the speed of data production. In addition, the envisioned automated transfer of data over a mobile network will strongly depend on the energy. As a result, manual retrieval of data from the base station and its subsequent upload to the AMMOD cloud platform needs to be designed in an error-proof manner, ensuring the seamless integration of data regardless of its time and route for delivery to the cloud. Last, but not least, AMMOD data should be archived long-term in an appropriate, preferably certified data center

and ultimately published with a persistent identifier (e.g. DOI) for proper referencing, in accordance with the FAIR data principles (Wilkinson et al., 2016).

Data management: approach

The overall architecture of the AMMOD data flow and its key components are depicted in Fig. 12. The functional blocks are color-coded to highlight the different subsystems involved and are grouped in six categories based on the role they have in the dataflow. The diagram is representative of the scenario with one fully equipped AMMOD platform located in one site, but the working principle remains valid for any number of AMMOD platforms and sensor configurations at different sites. Each sensor is expected to generate the raw and/or processed data (depending on the processing capabilities available at sensor level), metadata and telemetry data. Metadata describe the collected data (e.g. images, video or sound recording) and are essential for data integration (e.g. by location, collection date, sensor type) and analysis. Telemetry data deliver key parameters about the sensors (e.g. battery and storage status, measurement calibrations) and are essential for the active monitoring of the network, but additional sensors might also be required for analyses (e.g. analysis of “smellscapes”). The most important aspect of integrating data of heterogeneous sources is the consolidation of at least a minimum mandatory set of descriptors (or parameters). Both metadata and telemetry will be reported in a standardized, extensible JavaScript Object Notation (JSON) serialization and validated for mandatory parameters like time and location.

The data flow for all automated AMMOD sensors to the long-term data archives is as follows: First, the data generated by the AMMOD sensors are transferred to the AMMOD base station. From there, they are transmitted to a mediation component (broker agent) (A), which is responsible for further processing. The data is then transferred to the GFBio data centres (a German federation for biodiversity data: <http://www.gfbio.org/data-centers>) for long-term archiving and publication via established processes (B) and then stored in a cloud infrastructure via components developed in AMMOD (C), which enables the project partners and third-party users to access and analyze the data even before publication. With the availability of the network connectivity at the base station, the automated data transfer to the broker agent will be done over standardized Application Programming Interface (API). A technical solution that satisfies the data transfer requirement foreseen in AMMOD, i.e. large volume of data with individual file size of max 30–40 MB, is REST (https://en.wikipedia.org/wiki/Representational_state_transfer) API over the Hypertext Transfer Protocol (HTTP). For the upload of data which was manually recovered from the base station, a web-based interface, built on top of the same API will be used. The same APIs and web interfaces will be also used to deliver

metabarcoding data to the AMMOD cloud. Metabarcoding data is produced in a laboratory, specifically a sequencing facility, and will follow an alternative workflow to the AMMOD cloud as depicted in Fig. 12.

In order to keep a record of all stations and sensors, including detailed description, deployment information and unique identifiers, a central sensor registry is used. The sensor registry is a service dedicated at following purposes: 1) upon registration of a sensor device or base station, a unique identifier is assigned which helps keeping track of the network configuration as well as the data provenance/lineage; 2) store sensor-specific characteristics, e.g. parameter accuracy, geolocation, etc., and documentation, e.g. mount/unmount events, sensor calibration profiles, etc.

The AMMOD web portal provides the user interfaces for data search, visualization and sensor network monitoring. The web portal backend is accessing the information stored in dedicated services, like the sensor registry, over APIs and will provide an integrated view and access point to telemetry information, data and metadata.

The data management and archiving module builds on already established workflows and software components, adding specific functionality only where necessary. The backbone of the data brokerage and publication pipeline was developed as part of the GFBio project (www.gfbio.org) and has been operational for more than five years (Diepenbroek et al., 2014). The sensor registry is a service operated by the Alfred-Wegener Institute for Polar- and Marine Research (AWI) and includes (hundreds) thousands of sensors from global campaigns. Furthermore, all technical developments are aligned with the emerging national research data infrastructure (NFDI), specifically the NFDI4-BioDiversity consortium for (www.nfdi4biodiversity.org), to ensure the seamless integration of AMMOD data products into a broader national and international data landscape.

Building reference databases and involving citizen scientists

Reference databases are needed to analyze images, DNA-barcodes, animal sounds, and volatile organic compounds. In general, the compilation of reference data requires time and investments. However, this work already started many years ago (see below) and a huge amount of data is accumulating. And, even when databases are incomplete, the monitoring data usually allow to discern species (characterized by e.g. DNA sequences), and they can be listed with numbers and used for statistics even when names are not available. Names can be added later when databases are more complete.

DNA-barcoding databases

For DNA-barcoding, special rapidly growing DNA-databases exist (Ratnasingham & Hebert, 2013) which link

sequence data with species names or identification codes for species that still are unnamed (Zimmermann et al., 2014). Data on these molecular species-like taxonomic units (OTUs or ASVs, see metabarcoding chapter) are sufficient to study beta biodiversity, habitat preferences, and the geographic distribution of species. In a well-designed project samples with specimens are preserved in ethanol, allowing for subsequent morphology-based taxonomic studies.

Most experts that are trained to identify species (taxonomists) are citizen scientists. There exist a number of professionals at natural history museums, while most universities no longer teach in-depth organismic, species-based biology. It is therefore essential to involve citizen scientists to construct the required databases. A good example for a successful cooperation is the German Barcode of Life project (www.bolgermany.de). More than 270 expert citizen scientists are collecting animals and plants in Germany, which are determined by them and DNA barcoded at GBOL institutes (Geiger et al., 2016). Contributors receive a small allowance per sample, but are also rewarded with the publication of their contribution on the GBOL website and in publications, and they get training in analyses with this type of data. While many images can be harvested from initiatives like GBOL or the world-wide web, annotated animal sounds of good quality are more difficult to get. It will be necessary in many cases to make good recordings of species of interest.

Animal sound databases

Soundscapes are fingerprints of activities of all sound-producing animals of a landscape. It has been shown that differences between species-rich and poor habitats are obvious (e.g. Tucker et al., 2014; Krause & Farina, 2016). It is also possible to isolate single voices (Frommolt, Hüppop & Bardeli, 2012; Ross & Allen, 2014) and to estimate the number of different active species. However, to name these species, a complete reference database (animal sound archive) is required.

Open-access databases with annotated images of butterflies, moths, beetles, birds etc. are needed if we not only want to count the species but also name them with valid scientific names. Image databases are still not standardized, but several initiatives are building them for apps with species recognition tools that use artificial intelligence (e.g. SEEK and iNaturalist, observation.org, Flora Incognita, PlantNet). Cooperation with citizen experts is essential for completion of data and for verification. In future, these data systems should allow open access to all images and provide interfaces for applications.

Even if image databases are incomplete, it is still possible to discern shapes and colors (“morphotypes”) which then would get numbers instead of names. Such morphotypes are not necessarily species, they can also be races, sex variations etc.. Names can be added later as the reference database

grows. Unknown new objects can be identified and marked automatically for later analyses by experts (using swarm intelligence).

In principle, we must distinguish between (1) standardized reference data, whose number is limited by the number of species considered and the requirements for a sufficient representation of a species, and (2) the fast-growing monitoring data from fieldwork, which will have a much larger volume. In the future, in case the storage media become a bottleneck, a concept for an efficient and standardized management and eventually compaction of monitoring data has to be developed.

Future uses of biodiversity monitoring data

The principal application of the new technologies is the 24/7/365 surveillance of the presence and activity of species. The high observation frequency and the standardized simultaneous recording in many places at a large geographical scale (using AMMOD stations) is not possible with conventional methods. Though the automatized system does not cover the entire biodiversity, the number of species of animals, plants and other organisms that can be detected will be much higher than in any other multi-organismal monitoring scheme. Users want to have data for basic ecological research of pure academic interest, to test hypotheses (Lindenmayer & Likens 2010), but also for purposes of conservation biology, for analyses of effects of landscape management, and in general for the study of changes in anthropogenic and natural habitats.

The planned sensor platform that integrates different sensor modules offers a generic way for acquiring environmental information, data preprocessing, and exchanging the results and control data with other sensor platforms and a central receiver station. This resource can be used for a huge variety of applications.

Since a stationary detector is not suitable for a survey of plant communities, the AMMODs just deliver data points that are relevant in combination with e.g. remote sensing data used to map vegetation at a larger scale, however, with no fast turnover rates and no information about biome networks. Pollen analysis will allow qualitative (and potentially quantitative) biodiversity monitoring of local plant phenology, which is closely linked to climatic conditions and highly dependent on pollinator-plant interactions. Smellscapes complete the picture with additional prompt information on plant phenology. The relevance of flowering plants for the survival of insects can be studied, correlating insect presence, detected plant traces and pollen loads on insects captured in Malaise traps. The pollen data will also be useful for the pharmaceutical industry (e.g. to combat allergies). Insect data are relevant for the agricultural industry (e.g. analysis of pesticide effects, occurrence of pest insects and their natural enemies, e.g. Bianchi, Booij & Tscharnke, 2006), forestry (e.g. European spruce bark beetle, pine

processionary moth: Landmann et al., 2015) the food industry (e.g. honey monitoring, pollination of crop plants), environmental sciences and conservation biology.

The large-scale loss of insect populations observed during the past 20 years in Central Europe (e.g. Filz et al., 2012; Fox et al., 2013; Sorg et al., 2013; Habel et al., 2016) should be studied with high quality and comprehensive monitoring data. Only the correlation of monitoring data with specific landscape and land use changes will identify factors that are causing the rapid biodiversity losses. The AMMOD will have three different modules used for insect monitoring: a) the automatized Malaise trap (combined with metabarcoding), b) the automatized moth scanner (combined with the image recognition module), c) the sound recorder (e.g. for grasshoppers and crickets).

The determination of daily and seasonal activity patterns helps to understand the life history and ecology of the species (Hilje & Aide, 2012). This knowledge can be used for the development of species-specific conservation measures. Furthermore, it is a prerequisite for the design of meaningful recording schedules. The automated monitoring stations can create archives of recordings, which will largely contribute to our understanding of the effects of land-use changes on biodiversity and their consequences for ecosystem functioning and services. The Malaise trap modules will also create unique archives of genetic resources, which will in the future serve as important windows into the past and - given the technological advances in the high throughput sequencing sector - offer a plethora of new possibilities for answering also questions related to population genetics and genomics.

Sustainability indicators for species diversity (Sukopp, 2007; Dröschmeister & Sukopp, 2009), red-listed taxa, and threatened species (e.g. protected under EU legislation) are of special interest for biodiversity monitoring and crucial for the implementation of conservation measures. In the future, we will be able to determine the presence/absence of these indicators as well as daily and seasonal activity patterns of those species that are present for longer time periods.

The biomonitoring system could be used for inventorying and monitoring animal and plant species in the context of environmental impact assessments (EIAs). It would be particularly useful for pre-impact / post-impact environmental studies.

Migratory animals need special protection as their survival depends on habitats and food resources, which are dispersed over extensive areas, covering regions, countries, and continents (UNEP, 2003). Collision with man-made structures, such as wind turbines, power lines, communication towers, and skyscrapers, are an increasing problem for migratory birds and bats (e.g., Hüppop & Hilgerloh, 2012). On the basis of species-specific calling frequencies, we will develop algorithms to estimate the number of birds and bats that migrate through an area and the probability of collision with man-made structures. Automated acoustic and visual monitoring are ideal techniques to get a maximum amount

of data in protected areas, while keeping disturbance levels low. Likewise the system could be used to detect unauthorized human activities in protected areas, such as hunting, tree felling, and motocross racing. The GC-IMS technology will help to detect air-borne pesticides which might explain some diversity losses.

Since 1989, the German Common Birds Census (GCBC), conducted by the Federation of German Avifaunists (Dachverband Deutscher Avifaunisten, DDA), is the basis for monitoring the population trends of more widespread birds (Mitschke et al., 2005). In 2004 a new monitoring scheme based on a stratified randomized sampling design was implemented by the DDA in cooperation with the Federal Agency for Nature Conservation (Bundesamt für Naturschutz, BfN). The proposed automated monitoring units could help to overcome the shortage of volunteers and address some other method-specific issues, like observer bias and impacts of climate variability on bird detectability, by complementing the “classical” bird surveys with continuous automated monitoring. Furthermore, other groups of sound-producing animals, like insects, amphibians, and mammals, particularly bats, could be surveyed simultaneously without additional costs. We assume that with the introduction of the AMMODs new federal monitoring schemes will be developed that make use of the full potential of the AMMODs.

The spread of invasive alien species has been identified as one of the main causes of global biodiversity loss (Secretariat of the Convention on Biological Diversity 2010; UNEP 2012). Currently, more than 12,000 alien species have been catalogued for Europe alone by the DAISIE consortium (<https://www.gbif.org/dataset/39f36f10-559b-427f-8c86-2d28afff68ca>). The Environment Council of the European Commission has adopted a new regulation on invasive alien species, emphasizing that early detection is vital for taking action before the species have become established. Automated monitoring can be an important tool for detecting the appearance and spread of invasive species such as mammals (Caravaggi et al., 2016; Davis et al., 2018) via camera traps, or birds (e.g. Red-billed *Leiothrix lutea*: Farina, Pieretti & Morgantii, 2013) via acoustic monitoring, or the many alien insects (e.g. using DNA barcodes: Ball & Armstrong, 2006; Batovska et al., 2021; Javal et al., 2021) and plants that are already causing severe damages (e.g. Kenis & Branco, 2010). The new monitoring system will also be useful to detect sudden and unexpected changes in the vocal activity of common birds that might indicate a crisis caused by viruses like avian influenza.

Everywhere on this planet *land use* is a major cause for the loss of biodiversity. There are potentially harmful actions like the removal of trees and shrubs along streets (to protect the traffic or to sell the wood for pellet production) and fields (to increase the arable surface), the drying of wetland, or the straightening of streams. Other measures are planned specifically to help species to survive, like the construction of green bridges or improving the connectivity between habitats. Without monitoring it is impossible to

prove which changes are useful or harmful. Monitoring would be very important to optimize the allocation of resources and to objectify arguments.

The European Environmental Agency is not the only institution, but one of the most important ones that alarmed policy makers about ongoing losses of biodiversity in Europe (van Swaay et al., 2013; WWF, 2016). The statistics are based on data obtained for a few taxa (birds, grassland butterflies) and it is not clear what the trends are for other animals and plants and which other habitats are rapidly changing. Other monitoring initiatives use different standards and data are not comparable. The AMMODs will help to capture data for a much larger number of taxa in a standardized way.

The Intergovernmental Platform on Biodiversity and Ecosystem Services (IPBES) is the new global council for the observation of biodiversity trends. IPBES does not organize research programs but urgently needs data like inventories of local biological communities, analyses of trends, models for future scenarios, in analogy to the predictions published by climate researchers of the IPCC (Intergovernmental Panel on Climate Change). Currently, IPBES will have to publish assessments based on rough estimates and data obtained without standardization from very different organizations and citizen scientists. The AMMODs will revolutionize the way assessments will be done in future.

Costs and funding

A network of automated biological monitoring stations has never been built and operated. It is therefore not possible to estimate possible costs for stations built in serial production. AMMOD stations are modular. Therefore, costs will depend on the number of sensors used for a station, the recording period, the remoteness of the observation sites, availability of electricity.

Currently, the sensors we use are individually custom-made, improved after field tests, and produced in only small numbers. Therefore, the development phase is more expensive. However, due to the large interest in these technologies there exist parallel initiatives in various institutions developing prototypes for automated sensors, and cost-efficiency will improve in coming years. Also, for the near future miniaturization of sensors is the next step that requires further funding for hardware development.

For a single AMMOD prototype in a simple configuration, procurement and production costs for hardware range between 25.000 and 27.000 €. Adding more cameras and audiorecorders will increase costs depending on hardware quality. The most expensive additional module is the GC-IMS VOC detector (40.000 €), which therefore will be used only in special cases. The costs are comparable to those of professional stations used for climate research. Keeping in mind that billions have been spent for climate satellites, the

investments into biological monitoring should be acceptable.

AMMOD stations can be used by single research projects. Configuration and funding will then be project-specific. We cannot predict if governmental monitoring programs will use these stations, however, data quality, standardization, and low manpower requirements recommend their use. In future, institutes with long-term ecological research at the landscape level must have a budget for the operation of monitoring stations. Climate research is a model for this approach. Also, the central management, storage and accessibility of data has to be organized. Ongoing initiatives like the German Association for Research Data (NFDI: <https://www.nfdi.de/?lang=en>) pursue this goal.

Discussion

The need for large-scale biodiversity monitoring has been recognized since several years. The GEO-BON network was founded in 2008 (Scholes et al., 2008) to coordinate efforts globally. However, without modern technology data collection will remain rudimentary. We are interested in the detection of trends and we need fine-scaled data to analyze causes for biodiversity changes. Baird and Hajibabei (2012) proclaimed “biomonitoring 2.0” based on DNA barcoding, Bohan et al. (2017) recently called for *next generation global biomonitoring* based on DNA sequencing of environmental samples to reconstruct ecological networks with automated methods. We propose to go a step further and to build a research infrastructure that includes the technologies discussed in this paper, which are less intrusive than DNA-barcoding. Even though barcoding has the advantage to be applicable to any type of organism, the method requires physical sampling of tissue and in many cases cannot be used in an automated way, e.g. to monitor mammals or birds.

What has been lacking is the vision of a future where not only causes for climate change are better understood and controlled but also changes of the precious biosphere of our planet. Monitoring is urgently needed, because we are losing habitats and species every day, and the longer we wait, the poorer our planet will become. What we need to know is how unique local faunas and floras are and if communities are stable in time, where land use endangers the survival of species, which regions have a special responsibility for globally unique species. We have to know the consequences of further reductions of forests and wetlands, of construction of pipelines and highways through high nature landscapes, we have to learn if the planting of habitat corridors is efficient.

Scientists now agree that insect abundance experienced a dramatic decline worldwide over the last several decades (Collen et al., 2012; Dirzo et al., 2014). In Germany, between 70 and 80% of flying insects biomass disappeared in the last 20 years (Sorg et al., 2013; Hallmann et al., 2017; Vogel, 2017). Since biomass is not a good proxy for species diversity (e.g. Vereecken et al., 2021), future monitoring programs should identify samples down to the species level).

Losses of insect populations were also detected elsewhere (e.g. Woodcock et al., 2016; Habel et al., 2016; Harris, Rodenhouse & Holmes, 2019; Radda et al., 2019; Seibold et al., 2019; van Strien et al., 2019; Wagner, 2020). Significant net declines among animal species that provide pollination and pest control (Oliver, Heard, Isaac et al., 2015) is an alarming sign because of the obvious effects on ecosystem stability, crop production and food security (Potts et al., 2010). We have to keep in mind that 35% of the world food production relies on insects and 84% of the European cultivated plants depend on pollinators (IPBES, 2016). Bird species depending on insects showed a steeper decline in recent years both in Europe (Flade et al., 2008) and North America (Nebel et al., 2010). Similar losses probably occur elsewhere in the world. A parallel loss of populations and species in other taxa has also been documented (e.g. Ceballos, Ehrlich & Dirzo, 2017; Bowler et al., 2019; Busch et al., 2020).

The above conclusions about species declines would not have been possible without the work of volunteers. A convincing set of samples proving the deterioration of insect populations in Germany has been compiled by an NGO (Entomologischer Verein Krefeld) because these freelance scientists had been using standardized insect monitoring with Malaise traps for over 30 years (Sorg et al., 2013). Nobody else in Germany recorded data of this quality, and therefore neither academic research institutions nor responsible state agencies noted the rate of deterioration of our biological environment. Similarly, most data on insect populations used by scientists across Europe have been collected by volunteers via various recording schemes (Pocock et al., 2015; Schmeller et al., 2009).

On the other hand, in many cases citizen scientists do not use standardized sampling protocols and data are often erratic and may lack precise details of location. All the above significantly impedes data processing required to discover, confirm and predict current trends in biodiversity. If negative trends remain unknown, research to uncover the causes will not take place, and therefore there is no science-based advice for policy makers. Observations sampled and processed with the help of advanced technology should provide much more accurate results (Engler, Guisan & Rechsteiner, 2004). This, together with better involvement of the academic community into monitoring tasks will help with delivering faster and more informed decisions.

A combination of AMMODs, analyses of remote sensing data and observation data obtained by experts will enable us to achieve an impact similar to that of climate researchers. If we do not develop this infrastructure we will be complicit in the impoverishment of our planet’s biosphere.

This overview of available technologies demonstrates that all modules required to build a new infrastructure for large-scale and fine-grained biodiversity monitoring already exist. Five major elements are required: (1) long-term funding, (2) laboratories that routinely analyze satellite data to detect changes in habitat structure, (3) a network of sensor stations

(AMMODs) and receiver units for the signals of these stations, (4) integration of observation data (integrating citizen science), (5) research and computing centers that analyze all biodiversity data available from the environment to detect and understand trends, to develop scenarios and predictions, to recommend management measures. Traditional monitoring has been expensive and difficult, mainly due to the required large workforce, the biases resulting from human factors, and because the number of available experts (especially for taxonomy) has always been insufficient. With the new sensor technologies in combination with the advances in computer science and the growth of required data bases these obstacles can be overcome.

Conclusions

- 1 The ongoing global rapid loss of biodiversity is not sufficiently monitored. Dramatic declines e.g. of insect biodiversity in Europe and North America have been documented only locally for very few places and at a time when large changes already occurred. To prevent a further deterioration of our planet's biosphere, a monitoring infrastructure comparable to that used in climate research is required.
- 2 It is possible to automate the local detection of species using already available technologies. Animal sounds can be recorded, camera traps can be modified to identify and count insects, birds, mammals, or plant growth, airborne organic particles like pollen and flying insects can be sampled automatically to identify species based on DNA-barcoding, and analyses of air samples using GC-IMS give information on vegetation phenology or on characteristics of the soil microbiome.
- 3 The greatest challenges for the application of these technologies are the improvement of algorithms required for discrimination of species-specific signal patterns and the completion of reference databases.
- 4 AMMOD stations can also be deployed in places where many species are still undescribed. Species-specific signals will be discerned and classified, and if species names are missing other unique identifiers can be used instead.
- 5 To construct an infrastructure comparable to that used by climate researchers, we need the stationary AMMOD systems, a regular analysis of satellite images for habitat change monitoring, and computing and analyses centers where all available data are integrated, including observation data obtained by citizen scientists. Data and results should be freely available.

Declaration of Competing Interest

All other authors have nothing to declare.

Acknowledgement

This work was supported by the German Federal Ministry of Education and Research (development of AMMODs and of the German Barcode of Life database (GBOL)).

Supplementary materials

Supplementary material associated with this article can be found in the online version at [doi:10.1016/j.baae.2022.01.003](https://doi.org/10.1016/j.baae.2022.01.003).

References

- Ärje, J., Melvad, C., Jeppesen, M. R., Madsen, S. A., Raitoharju, J., Rasmussen, M. S., et al. (2020). Automatic image-based identification and biomass estimation of invertebrates. *Methods in Ecology and Evolution*, *11*, 1–10. doi:10.1111/2041-210X.13428.
- Astrin, J. J., Fonseca, V. G., Geiger, M. F., Grobe, P., Rulik, B., & Wägele, J. W. (2015). Lessons from the first phase of the German Barcode of life initiative (2012–2015). *Genome / National Research Council Canada = Genome / Conseil national de recherches Canada*, *58*, 190.
- Aylagas, E., Borja, A., & Rodríguez-Ezpeleta, N. (2014). Environmental status assessment using DNA metabarcoding: Towards a genetics based Marine Biotic Index (gAMBI). *PloS one*, *9*, e90529.
- Aylagas, E., Borja, Á., Irigoien, X., & Rodríguez-Ezpeleta, N. (2016). Benchmarking DNA Metabarcoding for Biodiversity-Based Monitoring and Assessment. *Frontiers in Marine Science*, *3*. doi:10.3389/fmars.2016.00096.
- Baird, D. J., & Hajibabaei, M. (2012). Biomonitoring 2.0: A new paradigm in ecosystem assessment made possible by next-generation DNA sequencing. *Molecular Ecology*, *21*, 2039–2044.
- Balfer, J., Schöler, F., & Steinhage, V. (2013). Semantic skeletonization for structural plant analysis. In *Proceedings of the 7th International Conference on Functional-Structural Plant Models (FSPM 2013), Saariselkä, Finland (pp. 42–44) June 9–14*.
- Balmford, A., Green, R. E., & Jenkins, M. (2003). Measuring the changing state of nature. *Trends in Ecology and Evolution*, *18*, 326–330.
- Ball, S. L., & Armstrong, K. F. (2006). DNA barcodes for insect pest identification: A test case with tussock moths (Lepidoptera: Lymantriidae). *Canadian Journal of Forest Research*, *36*, 337–350.
- Balla, E., Flórian, N., Gergócs, V., Gránicz, L., Tóth, F., Németh, T., et al. (2020). *Sensors*, *20*, 982. doi:10.3390/s20040982.
- Baschek, B., Schroeder, F., Brix, H., Riethmüller, R., Badewien, T. H., Breitbach, G., et al. (2017). The Coastal Observing System for Northern and Arctic Seas (COSYNA). *Ocean Science*, *13*, 379–410. doi:10.5194/os-2016-31.
- Batovska, J., Piper, A. M., Valenzuela, I., Cunningham, J. P., & Blacket, M. J. (2021). Developing a non-destructive metabarcoding protocol for detection of pest insects in bulk trap catches. *Scientific Reports*, *11*, 7946.
- Bell, K. L., Fowler, J., Burgess, K. S., Dobbs, E. K., Gruenewald, D., & Lawley, B. (2017). Applying pollen DNA metabarcoding to the study of plant–pollinator interactions. *Applications in Plant Science*, *5*, apps.1600124. doi:10.3732/apps.1600124.
- Benton, M. J., & Harper, D. A. T. (2009). *Introduction to paleobiology and the fossil record*. (p. 608). Chichester: Wiley-Blackwell.
- Bianchi, F. J. J. A., Booij, C. J. H., & Tscharntke, T. (2006). Sustainable pest regulation in agricultural landscapes: A review on landscape composition, biodiversity and natural pest control. *Proceedings of the Royal Society B: Biological Sciences*, *273*, 1715–1727.
- Bik, H. M., Sung, W., De Ley, P., Baldwin, J. G., Sharma, J., Rocha-Olivares, A., et al. (2012). Metagenetic community

- analysis of microbial eukaryotes illuminates biogeographic patterns in deep-sea and shallow water sediments. *Molecular Ecology*, 21, 1048–1059.
- Bjerge, K., Nielsen, J. B., Sepstrup, M. V., Helsing-Nielsen, F., & Høye, T. T. (2021). An automated light trap to monitor moths (Lepidoptera) using computer vision-based tracking and deep learning. *Sensors*, 21(2), 343. doi:10.3390/s21020343.
- Bodesheim, P., Freytag, A., Rodner, E., Kemmler, M., & Denzler, J. (2013). Kernel null space methods for novelty detection. *IEEE Conference on Computer Vision and Pattern Recognition (CVPR) 2013* (pp. 3374–3381).
- Bogena, H., Schulz, K., & Vereecken, H. (2006). Towards a network of observatories in terrestrial environmental research. *Advances in Geosciences*, 9, 1–6.
- Bohan, D. A., Vacher, C., Tamaddoni-Nezhad, A., Raybould, A., Dumbrell, A. J., & Woodward, G. (2017). Next-generation global biomonitoring: Large-scale, automated reconstruction of ecological networks. *Trends in Ecology and Evolution*, 23, 477–487.
- Bohmann, K., Evans, A., Gilbert, M. T. P., Carvalho, G. R., Creer, S., Knapp, M., et al. (2014). Environmental DNA for wildlife biology and biodiversity monitoring. *Trends in Ecology & Evolution*, 29, 358–367.
- Bonmarco, R., Lundin, O., Smith, H. G., & Rundlöf, M. (2012). Drastic historic shifts in bumble-bee community composition in Sweden. In *Proceedings of the Royal Society* (pp. 309–315).
- Bormpoudakis, D., Sueur, J., & Pantis, J. D. (2013). Spatial heterogeneity of ambient sound at the habitat type level: Ecological implications and applications. *Landscape Ecology*, 28, 495–506.
- Bowler, D., Heldbjerg, H., Fox, A. D., de Jong, M., & Böhning-Gaese, K. (2019). Long-term declines of European insectivorous bird populations and potential causes. *Conservation Biology*, 35, 11–20.
- Bolyen, E., Rideout, J. R., Dillon, M. R., Bokulich, N. A., & Abnet, C. C. (2019). Reproducible, interactive, scalable and extensible microbiome data science using QIIME 2. *Nature Biotechnology*, 37, 852–857. doi:10.1038/s41587-019-0209-9.
- Brantley, S., White, T., White, A., Sparks, D., Richter, D., Pregitzer, K., et al. (2006). The implementation of a stand-alone video tracking and analysis system for animal behavior measurement in Morris Water Maze. *Frontiers in Exploration of the Critical Zone: Report of a workshop sponsored by the National Science Foundation (NSF)*. doi:10.1109/IEMBS.2005.1616788.
- Brehm, G. (2017). A new LED lamp for the collection of nocturnal Lepidoptera and a spectral comparison of light-trapping lamps. *Nota Lepidopterologica*, 40, 87–108.
- Brooks, D. R., Bater, J. E., Clark, S. J., Monteith, D. T., Andrews, C., Corbett, S. J., et al. (2012). Large carabid beetle declines in a United Kingdom monitoring network increases evidence for a widespread loss in insect biodiversity. *Journal of Applied Ecology*, 49, 1009–1019.
- Brujning, M., Visser, M. D., Hallmann, C. A., & Jongejans, E. (2018). trackdem: Automated particle tracking to obtain population counts and size distributions from videos in R. *Methods in Ecology and Evolution*, 9, 965–973. doi:10.1111/2041-210X.12975.
- Brust, C. A., Burghardt, T., Groenenberg, M., Kaeding, C., Kuehl, H. S., et al. (2017). Towards automated visual monitoring of individual gorillas in the wild. *2017 IEEE International Conference of Computer Vision Workshop (ICCVW 2017)*. https://10.1109/ICCVW.2017.333.
- Burton, A. C., Neilson, E., Moreira, D., Ladle, A., Steenweg, R., Fisher, et al. (2015). Wildlife camera trapping: A review and recommendations for linking surveys to ecological processes. *Journal of Applied Ecology*, 52, 675–685.
- Busch, M., Katzenberger, J., Trautmann, S., Gerlach, B., Dröschmeister, R., & Sudfeldt, C. (2020). Drivers of population change in common farmland birds in Germany. *Bird Conservation International*, 30, 335–354. doi:10.1017/S0959270919000480.
- Bush, A., Monk, W. A., Compson, Z. G., Peters, D. L., Porter, T. M., Shokralla, S., et al. (2020). DNA metabarcoding reveals metacommunity dynamics in a threatened boreal wetland wilderness. In *Proceedings of the National Academy of Sciences* (pp. 8539–8545).
- Buxton, R. T., Brown, E., Sharman, L., Gabriele, C. M., & McKenna, M. F. (2016). Using bioacoustics to examine shifts in songbird phenology. *Ecology and Evolution*, 6, 4697–4710. doi:10.1002/ece3.2242.
- Çakır, E., Adavanne, S., Parascandolo, G., Drossos, K., & Virtanen, T. (2017). Convolutional recurrent neural networks for bird audio detection. *25th European Signal Processing Conference (EUSIPCO)* (pp. 1744–1748). doi:10.23919/EUSIPCO.2017.8081508.
- Callahan, B. J., McMurdie, P. J., & Holmes, S. P. (2017). Exact Sequence Variants Should Replace Operational Taxonomic Units in Marker-Gene Data Analysis. *The ISME Journal*, 11, 2639–2643.
- Caravaggi, A., Zaccaroni, M., Riga, F., Schai-Braun, S. C., Dick, T. A., Montgomery, I., et al. (2016). An invasive-native mammalian species replacement process captured by camera trap survey random encounter models. *Remote Sensing in Ecology and Conservation*, 2, 45–58.
- Carew, M. E., Pettigrove, V. J., Metzeling, L., & Hoffmann, A. A. (2013). Environmental monitoring using next generation sequencing: Rapid identification of macroinvertebrate bioindicator species. *Frontiers in Zoology*, 10, 45. doi:10.1186/1742-9994-1110-1145.
- Ceballos, G., Ehrlich, P. R., & Dirzo, R. (2017). *Biological annihilation via the ongoing sixth mass extinction signaled by vertebrate population losses and declines: 114* (pp. 1–8). PNAS.
- Chang, B., Hu, J., King, H. B., & Lin, F. P. (2004). *New wireless sensor network for studying lake metabolism: 17* Networks News Spring. http://news.1ternet.edu/Article427.html.
- Chao, A., & Chiu, C.-H. (2016). *Nonparametric estimation and comparison of species richness*. John Wiley & Sons, Ltd. doi:10.1002/9780470015902.a0026329.
- Collen, B., Böhm, M., Kemp, R., & Baillie, J. E. M. (2012). *Spineless: Status and trends of the world's invertebrates*. Zoological Society of London.
- Collett, R. A., & Fisher, D. O. (2017). Time-lapse camera trapping as an alternative to pitfall trapping for estimating activity of leaf litter arthropods. *Ecology and Evolution*, 7, 7527–7533.
- Creedy, T. J., Ng, W. S., & Vogler, A. P. (2019). Toward accurate species-level metabarcoding of arthropod communities from the tropical forest canopy. *Ecology and Evolution*, 9, 3105–3116. doi:10.1002/ece3.4839.
- Curtis, A. J., Helmig, D., Baroch, C., Daly, R., & Davis, S. (2014). Biogenic volatile organic compound emissions from nine tree

- species used in an urban tree-planting program. *Atmospheric Environment*, 95, 634–643.
- Darras, K., Batáry, P., Furnas, B. J., Grass, I., Mulyani, Y. A., & Tschamtko, T. (2019). Autonomous sound recording outperforms human observation for sampling birds: A systematic map and user guide. *Ecological Applications*, 29(6), E01954. doi:10.1002/eap.1954.
- Davis, A. J., McCreary, R., Psiropoulos, J., Brennan, G., Cox, T., Partin, A., et al. (2018). Quantifying site-level usage and certainty of absence for an invasive species through occupancy analysis of camera-trap data. *Biological Invasions*, 20, 877–890.
- de Kerdel, G. A., Andersen, J. C., Kennedy, S. R., Gillespie, R., & Krehenwinkel, H. (2020). Rapid and cost-effective generation of single specimen multilocus barcoding data from whole arthropod communities by multiple levels of multiplexing. *Scientific Reports*, 10, 1–12.
- Delisle, Z. J., Flaherty, E. A., Nobbe, M. R., Wzientek, C. M., & Swihart, R. K. (2021). Next-generation camera trapping: Systematic review of historic trends suggests keys to expanded research applications in ecology and conservation. *Frontiers in Ecology and Evolution*, 9, 97. doi:10.3389/fevo.2021.617996.
- Deng, J., Dong, W., Socher, R., Li, L. J., Li, K., & Fei-Fei, L. (2009). ImageNet: A Large-Scale Hierarchical Image Database. *International Conference on Computer Vision and Pattern Recognition (CVPR)*, 248–255. doi:10.1109/CVPR.2009.5206848.
- Depraetere, M., Pavoine, S., Jiguet, F., Gasc, A., Duvail, S., & Sœur, J. (2012). Monitoring animal diversity using acoustic indices: Implementation in a temperate woodland. *Ecological Indicators*, 13, 46–54.
- Di Francesco, M., Das, S. K., & Anastasi, G. (2011). Data collection in wireless sensor networks with mobile elements: A survey. *ACM Transactions on Sensor Networks*, 8, 1–31.
- Diepenbroek, M., Glöckner, F. O., Grobe, P., Güntsch, A., Huber, R., et al. (2014). Towards an integrated biodiversity and ecological research data management and archiving platform: The German federation for the curation of biological data (GFBio). *Informatik 2014 – Big Data Komplexität meistern. GI-Edition: Lecture Notes in Informatics (LNI) – Proceedings* (pp. 1711–1724). https://species-id.net/s/media/6/61/Gfbio_informatik2014.pdf.
- Ding, W., & Taylor, G. (2016). Automatic moth detection from trap images for pest management. *Computers and Electronics in Agriculture*, 123, 17–28.
- Dirzo, R., Young, H. S., Galetti, M., Ceballos, G., Isaac, N. J. B., & Collen, B. (2014). Defaunation in the anthropocene. *Science (New York, N.Y.)*, 345, 401–406.
- Drake, V. A., Wang, H. K., & Harman, I. T. (2002). Insect monitoring radar: Remote and network operation. *Computers and Electronics in Agriculture*, 35, 77–94.
- Drinkwater, R., Schnell, I. B., Bohmann, K., Bernard, H., Veron, G., Clare, E., et al. (2019). Using metabarcoding to compare the suitability of two blood-feeding leech species for sampling mammalian diversity in North Borneo. *Molecular Ecology Resources*, 19, 105–117. doi:10.1111/1755-0998.12943.
- Dröschmeister, R., & Sukopp, U. (2009). Indicators and conservation policy: The German Sustainability Indicator for Species Diversity as an example. *Avocetta*, 33, 149–156.
- Dudareva, N., Negre, F., Nagegowda, D. A., & Orlova, I. (2006). Plant Volatiles: Recent Advances and Future Perspectives. *Critical Reviews in Plant Sciences*, 25, 417–440.
- Dunker, S., Motivans, E., Rakosy, D., Boho, D., Mäder, P., Hornick, T., et al. (2021). Pollen analysis using multispectral imaging flow cytometry and deep learning. *New Phytologist*, 229, 593–606.
- Edmonds, R. L. (1979). *Aerobiology: The ecological systems approach*. pa: Dowden. Hutchinson & Ross.
- Ehrlich, P. R., & Pringle, R. M. (2008). Where does biodiversity go from here? A grim business-as-usual forecast and a hopeful portfolio of partial solutions. *Proceedings of the National Academy of Science*, 105, 11579–11586.
- Eiceman, G. A., Karpas, Z., & Hill, H. H. (2013). *Ion mobility spectrometry* (3rd edition). Taylor and Francis.
- Ekrem, T., Willassen, E., & Stur, E. (2007). A comprehensive DNA sequence library is essential for identification with DNA barcodes. *Molecular phylogenetics and evolution*, 43, 530–542.
- Ekrem, T., Alsos, I. G., Johnsen, A., Willassen, E., Aspaas, A. M., Foreid, M. K., et al. (2015). The Norwegian Barcode of Life Network (NorBOL). *Genome / National Research Council Canada = Genome / Conseil national de recherches Canada*, 58, 214.
- Elbrecht, V., Beermann, A. J., Goessler, G., Neumann, J., Tollrian, R., Wagner, R., et al. (2016). Multiple-stressor effects on stream invertebrates: A mesocosm experiment manipulating nutrients, fine sediment and flow velocity. *Freshwater Biology*, 61, 362–375.
- Elbrecht, V., Vamos, E. E., Meissner, K., Aroviita, J., & Leese, F. (2017). Assessing strengths and weaknesses of DNA metabarcoding-based macroinvertebrate identification for routine stream monitoring. *Methods in Ecology and Evolution*, 8, 1265–1275. doi:10.1111/2041-210X.12789.
- Ellipopoulos, P. A., Potamitis, I., & Rigakis, I. (2018). Automated detection and monitoring of grain beetles using a “smart” pitfall trap. *Julius-Kühn-Archiv*, 463, 268–272.
- Engler, R., Guisan, A., & Rechsteiner, L. (2004). An improved approach for predicting the distribution of rare and endangered species from occurrence and pseudo-absence data. *Journal of Applied Ecology*, 41, 263–274.
- Fagerlund, S. (2014). *Studies on Bird Vocalization Detection and Classification of Species. PhD thesis, Aalto University, Finland. Aalto Univ. Publ. Series, 166, 1–68.*
- Farina, A., Pieretti, N., & Piccioli, L. (2011). The soundscape methodology for long-term bird monitoring: A Mediterranean Europe case-study. *Ecological Informatics*, 6, 354–363.
- Farina, A., Pieretti, N., & Morgantini, N. (2013). Acoustic patterns of an invasive species: The Red-billed Leiothrix (*Leiothrix lutea* Scopoli 1786) in a Mediterranean shrubland. *Bioacoustics*, 22, 175–194.
- Field, S. A., O'Connor, P. J., Tyre, A. J., & Possingham, H. P. (2007). Making monitoring meaningful. *Austral Ecology*, 32, 485–491.
- Filz, K. J., Engler, J. O., Stoffels, J., Weitzel, M., & Schmitt, T. (2012). Missing the target? A critical view on butterfly conservation efforts on calcareous grasslands in south-western Germany. *Biodiversity and Conservation*, 22, 2223–2241.
- Fox, R., Parsons, M. S., Chapman, J. W., Woiwood, I. P., Warren, M. S., & Brooks, D. R. (2013). The state of Britain's larger moths 2013. Report Butterfly Conservation and Rothamsted Research, Wareham, U.K.. doi:10.23637/rothamsted.898z8.
- Flade, M., Grüneberg, C., Sudfeldt, C., & Wahl, J. (2008). Birds and Biodiversity in Germany –2010 Target. *DDA, NABU, DRV, DO-G, Münster*, 31.

- Floyd, R., Abebe, E., Papert, A., & Blaxter, M. (2002). Molecular barcodes for soil nematode identification. *Molecular Ecology*, *11*, 839–850.
- Follmann, P., & Radig, B. (2018). Detecting animals in infrared images from camera-traps. *Pattern Recognition and Image Analysis*, *28*, 605–611.
- Fonseca, V., Carvalho, G., Nichols, B., Quince, C., Johnson, H., Neill, S., et al. (2014). Metagenetic analysis of patterns of distribution and diversity of marine meiobenthic eukaryotes. *Global Ecology and Biogeography*, *23*, 1293–1302.
- Fonseca, V., Carvalho, G., Sung, W., Johnson, H., Power, D., Neill, S., et al. (2010). Second-generation environmental sequencing unmasks marine metazoan biodiversity. *Nature Communications*, *1*, 98.
- Forrester, T., O'Brien, T., Fegraus, E., Jansen, P., Palmer, J., Kays, R., et al. (2016). An open standard for camera trap data. *Biodiversity Data Journal*, *2016*(4), e10197. doi:10.3897/BDJ.4.e10197.
- Freytag, A., Rodner, E., & Denzler, J. (2014). Selecting influential examples: Active learning with expected model output changes. *European Conference on Computer Vision – ECCV 2014 - Lecture Notes in Computer Science* (pp. 562–577). doi:10.1007/978-3-319-10593-2_37.
- Freytag, A., Rodner, E., Simon, M., Loos, A., Kühl, H. S., & Denzler, J. (2016). Chimpanzee faces in the wild: Log-euclidean CNNs for predicting identities and attributes of primates. German Conference on Pattern Recognition. *GCPR 2016, Lecture Notes in Computer Science*, *9796*, 51–63. doi:10.1007/978-3-319-45886-1_5.
- Frommolt, K.-H., & Tauchert, K.-H. (2014). Applying bioacoustic methods for long-term monitoring of a nocturnal wetland bird. *Ecological Informatics*, *21*, 4–12.
- Frommolt, K.-H., Hüppop, O., Bardeli, R., Hill, R., Koch, M., Tauchert, K.-H., et al. (2012). Automatisierte Methoden der Erfassung von Rufen und Gesängen in der avifaunistischen Feldforschung. *Vogelwarte*, *50*, 65–78.
- Fuller, S., Axel, A. C., Tucker, D., & Gage, S. H. (2015). Connecting soundscape to landscape: Which acoustic index best describes landscape configuration? *Ecological Indicators*, *58*, 207–215.
- Gage, S. H., & Axel, A. C. (2014). Visualization of temporal change in soundscape power of a Michigan lake habitat over a 4-year period. *Ecological Informatics*, *21*, 100–109.
- Ganchev, T., Mporas, I., Jahn, O., Riede, K., Schuchmann, K.-L., & Fakotakis, N. (2012). *Acoustic bird activity detection on real-field data*. SETN Conference on Artificial Intelligence: Theories and Applications. *Lecture Notes in Computer Science*, *7297*, 190–197. doi:10.1007/978-3-642-30448-4_24.
- Gardner, T. A., Barlow, J., Araujo, I. S., Avila-Pires, T. C., Bonaldo, A. B., et al. (2008). The cost-effectiveness of biodiversity surveys in tropical forests. *Ecology Letters*, *11*, 139–150.
- Gasc, A., Pavoine, S., Lellouch, L., Grandcolas, P., & Sœur, J. (2015). Acoustic Indices for Biodiversity Assessments: Analyses of Bias Based on Simulated Bird Assemblages and Recommendations for Field Surveys. *Biological Conservation*, *191*, 306–312. doi:10.1016/j.biocon.2015.06.018.
- Geiger, M. F., Astrin, J. J., Borsch, T., Burkhardt, U., Grobe, P., Hand, R., et al. (2016). How to tackle the molecular species inventory for an industrialized nation—Lessons from the first phase of the German Barcode of Life initiative GBOL (2012–2015). *Genome / National Research Council Canada = Genome / Conseil national de recherches Canada*, *59*, 661–670.
- Gibson, J. F., Shokralla, S., Curry, C., Baird, D. J., Monk, W. A., King, I., et al. (2015). Large-scale biomonitoring of remote and threatened ecosystems via high-throughput sequencing. *PLoS one*, *10*, e0138432. doi:10.1371/journal.pone.0138432.
- Giebner, H., Langen, K., Bourlat, S. J., Kukowka, S., Mayer, C., & Astrin, J. J. (2019). Comparing diversity levels in environmental samples: DNA sequence capture and metabarcoding approaches using 18S and COI genes. *Molecular Ecology Resources*, *20*, 1–13. doi:10.1111/1755-0998.13201.
- Giesecke, T., Fontana, S. L., van der Knaap, W. O., Pardoe, H. S., & Pidek, I. A. (2010). From early pollen trapping experiments to the Pollen Monitoring Programme. *Vegetation History and Archaeobotany*, *19*, 247–258.
- Goëau, H., Kahl, S., Glotin, H., Planqué, R., Vellinga, W. P., Joly, A., et al. (2018). Overview of BirdCLEF 2018: Monospecies vs. soundscape bird identification. Conference and Labs of the Evaluation Forum (CLEF) September 2018. http://ceur-ws.org/Vol-2125/invited_paper_9.pdf.
- Gossner, M. M., Struwe, J.-F., Sturm, S., Max, S., McCutcheon, M., & Weisser, W. W. (2016). Searching for the optimal sampling solution: Variation in invertebrate communities, sample condition and DNA quality. *PLoS one*, *11*, e0148247. doi:10.1371/journal.pone.0148247.
- Gottwald, J., Zeidler, R., Friess, N., Ludwig, M., Reudenbach, C., & Nauss, T. (2019). Introduction of an automatic and open-source radio-tracking system for small animals. *Methods in Ecology and Evolution*, *10*, 2163–2172. doi:10.1111/2041-210X.13294.
- Goulson, D., Nicholls, E., Botías, C., & Rotheray, E. L. (2015). Bee declines driven by combined stress from parasites, pesticides, and lack of flowers. *Science (New York, N.Y.)*, *347*, 1435.
- Grant, P. B. C., & Samways, M. J. (2016). Use of ecoacoustics to determine biodiversity patterns across ecological gradients. *Conservation Biology*, *30*, 1320–1329.
- Gregory, P. H. (1973). The Microbiology of the atmosphere. *Netherlands Journal of Plant Pathology*, *79*, 1–377. doi:10.1007/BF01976673.
- Gregory, T., Carrasco Rueda, F., Deichmann, J., Kolowski, J., & Alonso, A. (2014). Arboreal camera trapping: Taking a proven method to new heights. *Methods in Ecology and Evolution*, *5*, 443–451.
- Guan, Z., Brydegaard, M., Lundin, P., Wellenreuther, M., Runemark, A., & Svensson, E. I. (2010). Insect monitoring with fluorescence lidar techniques: Field experiments. *Applied Optics*, *49*, 5133–5142.
- Guardiola, M., Wangenstein, O. S., Taberlet, P., Coissac, E., Uriz, & Turon, X (2016). Spatio-temporal monitoring of deep-sea communities using metabarcoding of sediment DNA and RNA. *PeerJ*, *4*, e2807. doi:10.7717/peerj.2807 <https://doi.org/10.7717/peerj.2807>
- Habel, J. C., Segerer, A., Ulrich, W., Torchyk, O., Weisser, W. W., & Schmitt, T. (2016). Butterfly community shifts over two centuries. *Conservation Biology*, *30*, 754–762.
- Hajibabaei, M., Shokralla, S., Zhou, X., Singer, G. A., & Baird, D. J. (2011). Environmental barcoding: A next-generation sequencing approach for biomonitoring applications using river benthos. *PLoS one*, *6*, e17497.
- Hajibabaei, M., Spall, J. L., Shokralla, S., & van Konyenburg, S. (2012). Assessing biodiversity of a freshwater benthic macroinvertebrate community through non-

- destructive environmental barcoding of DNA from preservative ethanol. *BMC ecology*, 12, 28.
- Hallmann, C. A., Sorg, M., Jongejans, E., Siepel, H., Hofland, N., Schwan, H., et al. (2017). More than 75 percent decline over 27 years in total flying insect biomass in protected areas. *PloS one*, 12, E0185809.
- Harris, J. E., Rodenhouse, N. L., & Holmes, R. T. (2019). Decline in beetle abundance and diversity in an intact temperate forest linked to climate warming. *Biological Conservation*, 240, 1–8.
- Haucke, T., & Steinhage, V. (2021). Exploiting depth information for wildlife monitoring. *Computing Research Repository (CoRR)*, abs/2102.05607 <https://doi.org/abs/2102.05607>.
- Hausmann, A., Segerer, A.H., Greifenstein, T., Knubben, J., Morinière, T., Bozicevic, V., et al. (2020). Towards a standardized quantitative and qualitative insect monitoring scheme *Ecology and Evolution*, 10, 4009–4020. <https://doi.org/10.1002/ece3.6166>.
- He, K., Gkioxari, G., Dollár, P., & Girshick, R. (2017). Mask R-CNN. *International Conference on Computer Vision (ICCV), Venice 2017*, 2980–2988. doi:10.1109/ICCV.2017.322.
- Hebert, P. D. N., Ratnasingham, S., & Dewaard, J. R. (2003). Barcoding animal life: Cytochrome c oxidase subunit I divergences among closely related species. In *Proceedings of the Royal Society B: Biological Sciences* (pp. S596–S599).
- Herrera, A., Héry, M., Stach, J. E. M., Jaffré, T., Norman, P., & Navarro, E. (2007). Species richness and phylogenetic diversity comparisons of soil microbial communities affected by nickel-mining and revegetation efforts in New Caledonia. *European Journal of Soil Biology*, 43, 130–139.
- Herzog, F., & Franklin, J. (2016). State-of-the art practices in farmland biodiversity monitoring for North America and Europe. *Ambio*, 45, 857–871.
- Hilje, B., & Aide, T. M. (2012). Calling activity of the common tink frog (*Diasporus diastema*) (Eleutherodactylidae) in secondary forests of the Caribbean of Costa Rica. *Tropical Conservation Science*, 5, 25–37.
- Hirst, J. M. (1952). An automatic volumetric spore trap. *Annals of Applied Biology*, 39, 257–265.
- Hofmann, F., Otto, M., & Wosniok, W. (2014). Maize pollen deposition in relation to distance from the nearest pollen source under common cultivation - results of 10 years of monitoring (2001 to 2010). *Environmental Sciences Europe Bridging Science and Regulation at the Regional and European Level*, 26, 24.
- Homburg, K., Drees, C., Boutaud, E., Nolte, D., Schuett, W., Zumstein, P., et al. (2019). Where have all the beetles gone? Long-term study reveals carabid species decline in a nature reserve in Northern Germany. *Insect Conservation and Diversity*, 12, 1–10.
- Howe, E. J., Buckland, S. T., Despres-Einspenner, M.-L., & Kühl, H. S. (2017). Distance sampling with camera traps. *Methods in Ecology and Evolution*, 8, 1558–1565. doi:10.1111/2041-210X.12790 2017.
- Hüppop, O., & Hilgerloh, G. (2012). Flight call rates of migrating thrushes: Effects of wind conditions, humidity and time of day at an illuminated offshore platform. *Journal of Avian Biology*, 43, 85–90.
- Iannarilli, F., Erb, J., Arnold, T. W., & Fieberg, J. R. (2020). Evaluating species-specific responses to camera-trap survey designs: 2021 Wildlife Biology. doi:10.2981/wlb.00726.
- IPBES, Potts, S. G., Imperatriz-Fonseca, V. L., Ngo, H. T., Biesmeijer, J. C., Breeze, T. D., Dicks, L. V., et al. (2016). Summary for policymakers of the assessment report of the Intergovernmental Science-Policy Platform on Biodiversity and Ecosystem Services on pollinators, pollination and food production. *Secretariat of the intergovernmental science-policy platform on biodiversity and ecosystem services* (p. 36). Germany: Bonn pages.
- Jahn, O., Ganchev, T. D., Marques, M. I., & Schuchmann, K.-L. (2017). Automated sound recognition provides insights into the behavioral ecology of a tropical bird. *PloS one*, 12, e0169041. doi:10.1371/journal.pone.0169041.
- Janzen, D. H., Hallwachs, W., Blandin, P., Burns, J. M., Cadiou, J. M., Chacon, I., et al. (2009). Integration of DNA barcoding into an ongoing inventory of complex tropical biodiversity. *Molecular Ecology Resources*, 9, 1–26.
- Javal, M., Terblanche, J. S., Conlong, D. E., Delahaye, N., Grobbelaar, E., Benoit, L., et al. (2021). DNA barcoding for bio-surveillance of emerging pests and species identification in Afrotropical Prioninae (Coleoptera, Cerambycidae). *Biodiversity Data Journal*, 9, e64499. doi:10.3897/BDJ.9.e64499.
- Ji, Y., Ashton, L., Pedley, S. M., Edwards, D. P., Tang, Y., Nakamura, A., et al. (2013). Reliable, verifiable and efficient monitoring of biodiversity via metabarcoding. *Ecology Letters*, 16, 1245–1257.
- Käding, C., Freytag, A., Rodner, E., Bodesheim, P., & Denzler, J. (2015). Active learning and discovery of object categories in the presence of unnameable instances. In *Proceedings of the IEEE Conference on Computer Vision and Pattern Recognition (CVPR) 2015* (pp. 4343–4352). doi:10.1109/CVPR.2015.7299063.
- Käding, C., Freytag, A., Rodner, E., Perino, A., & Denzler, J. (2016). Large-scale active learning with approximated expected model output changes. In *Proceedings of the 38th German Conference on Pattern Recognition (GCPR) 2016* (pp. 179–191). doi:10.1007/978-3-319-45886-1_15.
- Kahl, S., Stöter, F.-R., Göeau, H., Glotin, H., Planque, R., Vellinga, W.-P., et al. (2019). Overview of BirdCLEF 2019: Large-scale bird recognition in soundscapes. *Conference and Labs of the Evaluation Forum (CLEF) September 2019*. http://ceur-ws.org/Vol-2380/paper_256.pdf.
- Kalan, A. K., Mundry, R., Wagner, O. J. J., Heinicke, S., Boesch, C., & Kuel, H. (2015). Towards the automated detection and occupancy estimation of primates using passive acoustic monitoring. *Ecological Indicators*, 54, 217–226.
- Keck, F., Vasselon, V., Tapolczai, K., Rimet, F., & Bouchez, A. (2017). Freshwater biomonitoring in the Information age. *Frontiers in Ecology and the Environment*, 15, 266–274.
- Kenis, M., & Branco, M. (2010). Impact of alien terrestrial arthropods in Europe. *BioRisk*, 4, 51–71.
- Kim, H. G., Park, J. S., & Lee, D. H. (2018). Potential of unmanned aerial sampling for monitoring insect populations in rice fields. *Florida Entomologist*, 101, 330–334.
- Kirkeby, C., Wellenreuther, M., & Brydegaard, M. (2016). Observations of movement dynamics of flying insects using high resolution lidar. *Scientific Reports*, 6, 29083. doi:10.1038/srep29083.
- Knudsen, J. T., Eriksson, R., Gershenzon, J., & Stahl, B. (2006). Diversity and distribution of floral scent. *Botanical Reviews*, 72, 1–120.

- Knudsen, J. T., Tollsten, L., & Bergstrom, G. (1993). Floral Scents—A checklist of volatile compounds isolated by head-space techniques. *Phytochemistry*, *33*, 253–280.
- Koch, W. (2016). *Tracking and sensor data fusion*. Berlin: Springer-Verlag.
- Kolter, A., & Gemeinholzer, B. (2020). Plant DNA barcoding necessitates marker-specific efforts to establish more comprehensive reference databases. *Genome / National Research Council Canada = Genome / Conseil national de recherches Canada*, *64*, 265–298. doi:10.1139/gen-2019-0198.
- Kong, Q., Cao, Y., Iqbal, T., Wang, Y., Wang, W., & Plumbley, M. D. (2019). PANNs: Large-scale pretrained audio neural networks for audio pattern recognition. *IEEE/ACM Transactions on Audio, Speech, and Language Processing* (pp. 2880–2894) arXiv preprint.
- Kormann, U., Rosch, V., et al. (2015). Local and landscape management drive trait-mediated biodiversity of nine taxa on small grassland fragments. *Diversity and Distributions*, *21*, 1204–1217.
- Korsch, D., Bodesheim, P., & Denzler, J. (2019). Classification-specific parts for improving fine-grained visual categorization. *German Conference on Pattern Recognition (DAGM GCPR) 2019* (pp. 62–75). Lecture Notes in Computer Science. doi:10.1007/978-3-030-33676-9_5.
- Köhler, J., Vieites, D. R., Bonett, R. M., Hita Garcia, F., Glaw, F., Steinke, D., et al. (2005). New amphibians and global conservation: A boost in species discoveries in a highly endangered vertebrate group. *Bioscience*, *55*, 693–696.
- Krause, B., & Farina, A. (2016). Using ecoacoustic methods to survey the impacts of climate change on biodiversity. *Biological Conservation*, *195*, 245–254.
- Kress, W. J. (2017). Plant DNA barcodes: Applications today and in the future. *Journal of Systematics and Evolution*, *55*, 291–307.
- Kydd, J., Rajakaruna, H., Briski, E., & Baile, S. (2017). Examination of a high-resolution laser optical plankton counter and FlowCAM for measuring plankton concentration and size. *Journal of Sea Research*, *133*, 2–10. doi:10.1016/j.seares.2017.01.003.
- Lamb, P. D., Hunter, E., Pinnegar, J. K., Creer, S., Davies, R. G., & Taylor, M. I. (2019). How quantitative is metabarcoding: A meta-analytical approach. *Molecular Ecology*, *28*, 420–430. doi:10.1111/mec.14920.
- Landmann, G., Held, A., Schuck, A., & Van Brusselen, J. (2015). *European forests at risk. a scoping study in support of the development of a european forest risk facility*. European Forest Institute. doi:10.13140/RG.2.1.1927.2169.
- Lasseck, M. (2019). Bird species identification in soundscapes. *CEUR Workshop Proceedings. CLEF 2019*. http://ceur-ws.org/Vol-2380/paper_86.pdf.
- Laussmann, T., Radtke, A., Wiemert, T., & Dahl, A. (2009). 150 Jahre Schmetterlingsbeobachtung in Wuppertal - Auswirkungen von Klima- und Landschaftsveränderungen (Lepidoptera). *Jahresberichte des Naturwissenschaftlichen Vereins Wuppertal*, *61*, 31–100.
- Lecun, Y., Bengio, J., & Hinton, G. (2015). Deep Learning. *Nature*, *521*, 436–444.
- Leontidou, K., Vokou, D., Sandionigi, A., et al. (2021). Plant biodiversity assessment through pollen DNA metabarcoding in Natura 2000 habitats (Italian Alps). *Scientific Reports*, *11*, 18226. doi:10.1038/s41598-021-97619-3.
- Levetin, E., Rogers, C. A., & Hall, S. A. (2000). Comparison of pollen sampling with a Burkard Spore Trap and a Tauber Trap in a warm temperate climate. *Grana*, *39*, 294–302.
- Lindenmayer, D. B., & Likens, G. E. (2010). The science and application of ecological monitoring. *Biological Conservation*, *143*, 1317–1328.
- Littlewood, N. A., Hancock, M. H., Newey, S., Shackelford, G., & Toney, R. (2021). Use of a novel camera trapping approach to measure small mammal responses to peatland restoration. *European Journal of Wildlife Research*, *67*, 1–10.
- Liu, M., Clarke, L. J., Baker, S. C., Jordan, G. J., & Burridge, C. P. (2019). A practical guide to DNA metabarcoding for entomological ecologists. *Ecological Entomology*, *45*, 373–385. doi:10.1111/een.12831.
- Locey, K. J., & Lennon, J. T. (2016). Scaling laws predict global microbial diversity. *Proceedings of the National Academy of Sciences*, *113*, 5970–5975. doi:10.1073/pnas.1521291113.
- Lombard, F., Boss, E., Waite, A. M., Vogt, M., Uitz, J., Stemmann, L., et al. (2019). Globally consistent quantitative observations of planktonic ecosystems. *Frontiers in Marine Science*, *6*, 196. doi:10.3389/fmars.2019.00196.
- Loos, A., & Ernst, A. (2013). An automated chimpanzee identification system using face detection and recognition. *EURASIP Journal on Image and Video Processing*, *49*. doi:10.1186/1687-5281-2013-49.
- López, O., Rach, M. M., Migallon, H., Malumbres, M. P., Bonastre, A., & Serrano, J. J. (2012). Monitoring pest insect traps by means of low-power image sensor technologies. *Sensors*, *12*, 15801–15819.
- Lynggaard, C., Nielsen, M., Santos-Bay, L., Gastauer, M., Oliveira, G., & Bohmann, K. (2019). Vertebrate diversity revealed by metabarcoding of bulk arthropod samples from tropical forests. *Environmental DNA*, *1*, 329–341. doi:10.1002/edn3.34.
- MacKenzie, D. I., Nichols, J. D., Royle, J. A., Pollock, K. H., Bailey, L., & Hines, J. E. (2017). *Occupancy estimation and modeling: Inferring patterns and dynamics of species occurrence*. Elsevier.
- Mainwaring, A., Culler, D., Polastre, J., Szewczyk, R., & Anderson, J. (2002). Wireless sensor networks for habitat monitoring. *WSNA '02: Proceedings of the 1st ACM international workshop on wireless sensor networks and applications* (pp. 88–97). doi:10.1145/570738.570751.
- Majaneva, M., Diserud, O. H., Eagle, S. H. C., Boström, E., Hajibabaei, M., & Ekrem, T. (2018). Environmental DNA filtration techniques affect recovered biodiversity. *Scientific Reports*, *8*, 4682. doi:10.1038/s41598-018-23052-8 article.
- Matin, M. A., & Islam, M. M. (2012). Overview of wireless sensor network. *wireless sensor networks – technology and protocols*. Rijeka: InTech Publisher. doi:10.5772/49376.
- McElveen, D., & Meyer, R. T. (2020). An effective and affordable camera trap for monitoring flower visiting butterflies in sand hills, with implications for the frosted elfin (*Callophrys irus*). *Journal of Pollination Ecology*, *26*, 12–15.
- Mele, K. (2013). Insect soup challenge: Segmentation, counting, and simple classification. *2013 IEEE International Conference on Computer Vision Workshops* (pp. 168–171). doi:10.1109/ICCVW.2013.28.
- Mihoub, J.-B., Henle, K., Titeux, N., Brotons, L., Brummit, N. A., & Schmeller, D. S. (2017). Setting temporal baselines for biodiversity: The limits of available monitoring data for capturing

- the full impact of anthropogenic pressures. *Scientific Reports*, 7, 41591. doi:10.1038/srep41591 <https://doi.org/10.1038/srep41591>
- Mitschke, A., Sudfeldt, C., Heidrich-Riske, H., & Dröschmeister, R. (2005). *Das neue brutvogelmonitoring in der normallandschaft deutschlands - Untersuchungsgebiete, erfassungsmethode und erste ergebnisse: 126* (pp. 127–140). Vogelwelt.
- Mora, C., Tittensor, D. P., Adl, S., Simpson, A. G. B., & Worm, B. (2011). How many species are there on earth and in the ocean? *PLOS Biology*, 9, E1001127. doi:10.1371/journal.pbio.1001127.
- Morinière, .. J., Cancian de Araujo, B., Lam, A. W., Hausmann, A., Balke, M., et al. (2016). Species identification in Malaise trap samples by DNA barcoding based on NGS technologies and a scoring matrix. *PLoS one*, 11, e0155497.
- Mortimer, J. A. J., & Greene, T. C. (2017). Investigating bird call identification uncertainty using data from processed audio recordings. *New Zealand Journal of Ecology*, 41, 126–133.
- Muhlemann, J. K., Klempien, A., & Dudareva, N. (2014). Floral volatiles: From biosynthesis to function. *Plant, Cell and Environment*, 37, 1936–1949.
- Nebel, S., Mills, A., McCracken, J. D., & Taylor, P. D. (2010). Declines of aerial insectivores in North America follow a geographic gradient. *Avian Conservation and Ecology*, 5(1). doi:10.5751/ACE-00391-050201.
- Nkongolo, K. K., & Narendula-Kotha, R. (2020). Advances in monitoring soil microbial community dynamic and function. *Journal of Applied Genetics*, 61, 249–263.
- O'Connell, A. F., Nichols, J. D., & Karanth, K. U. (2010). *Camera traps in animal ecology: Methods and analyses*. Springer Science & Business Media.
- Oliver, T. H., Heard, M. S., Isaac, N. J. B., Roy, D. B., Procter, D., Eigenbrod, F., et al. (2015). Biodiversity and resilience of ecosystem functions. *Trends in Ecology and Evolution*, 30, 673–684.
- Osterloff, J., Nilssen, I., Järnegren, J., Van Engeland, T., Buhl-Mortensen, P., & Nattkemper, T. W. (2019). Computer vision enables short- and long-term analysis of *Lophelia pertusa* polyp behaviour and colour from an underwater observatory. *Scientific Reports*, 9. doi:10.1038/s41598-019-41275-1 article number 6587.
- Pagonas, N., Vautz, W., Seifert, L., Slodzinski, R., Jankowski, J., Zidek, W., et al. (2012). Volatile organic compounds in uremia. *PLoS one*, 7, 1–9.
- Paneque-Gálvez, J., McCall, K. C., Napoletano, B. M., Wich, S. A., & Pin Koh, L. (2014). Small drones for community-based forest monitoring: An assessment of their feasibility and potential in tropical areas. *Forests*, 5, 1481–1507.
- Penar, W., Magiera, A., & Klocek, C. (2020). Applications of bioacoustics in animal ecology. *Ecological complexity*, 43, 100847. doi:10.1016/j.ecocom.2020.100847 article.
- Pennisi, E. (2010). A ground breaking observatory to monitor the environment. *Science (New York, N.Y.)*, 328(5977), 418–420 2010.
- Peñueals, J., & Lluisà, J. (2015). Plant VOC emissions: Making use of the unavoidable. *Trends in Ecology and Evolution*, 19, 402–404.
- Peñuelas, J., & Staudt, M. (2010). BVOCs and global change. *Trends in Plant Science*, 15, 133–144.
- Pérez-Granados, C., & Traba, J. (2021). Estimating bird density using passive acoustic monitoring: A review of methods and suggestions for further research. *Ibis*. <https://doi.org/10.1111/ibi.12944>.
- Perl, T., Carstens, E., TH, Hirn, A., Quintel, M., Vautz, W., et al. (2009). Determination of Serum Propofol Concentrations by Breath Analysis using Mobility Spectrometry. *British Journal of Anaesthesia*, 103, 822–827.
- Perl, T., Jünger, M., Vautz, W., Nolte, J., Kuhns, M., Borg-von Zepelin, M., et al. (2011). Detection of characteristic metabolites of *Aspergillus fumigatus* and *Candida* species using ion mobility spectrometry – metabolic profiling by volatile organic compounds. *Mycoses*, 54(6), e828–e837.
- Pieretti, N., Farina, A., & Morri, D. (2011). A new methodology to infer the singing activity of an avian community: The Acoustic Complexity Index (ACI). *Ecological Indicators*, 11, 868–873.
- Pin Koh, L., & Wich, S. A. (2012). Dawn of drone ecology: Low-cost autonomous aerial vehicles for conservation. *Tropical Conservation Science*, 5, 121–132.
- Piñol, J., Senar, M. A., & Symondson, W. O. C. (2019). The choice of universal primers and the characteristics of the species mixture determine when DNA metabarcoding can be quantitative. *Molecular Ecology*, 28, 407–419. doi:10.1111/mec.14776.
- Piper, A. M., Batovska, J., Cogan, N. O. I., Weiss, J., Cunningham, J. P., & Rodoni, B. C. (2019). Prospects and challenges of implementing DNA metabarcoding for high-throughput insect surveillance. *GigaScience*, 8, giz092. doi:10.1093/gigascience/giz092.
- Pocock, M. J. O., Newson, S. E., Henderson, I. G., Peyton, J., Sutherland, W. J., & Noble, D. G. (2015). Developing and enhancing biodiversity monitoring programmes: A collaborative assessment of priorities. *Journal of Applied Ecology*, 52, 686–695.
- Porter, J., Arzberger, P., Braun, H. W., Bryant, P., Gage, S., Hansen, T., et al. (2005). Wireless sensor networks for ecology. *Bioscience*, 55, 561–572.
- Potamitis, I., Ntalampiras, S., Jahn, O., & Riede, K. (2014). Automatic bird sound detection in long realfield recordings: Applications and tools. *Applied Acoustics*, 80, 1–9.
- Potts, S. G., Biesmeijer, J. C., Kremen, C., Neumann, P., Schweiger, O., & Kunin, W. E. (2010). Global pollinator declines: Trends, impacts, and drivers. *Trends in Ecology and Evolution*, 25, 345–353.
- Priyadarshani, N., Marsland, S., & Castro, I. (2018). Automated birdsong recognition in complex acoustic environments: A review. *Journal of Avian Biology*, 49(5), jav-01447. doi:10.1111/jav.01447.
- Rada, S., Schweiger, O., Harpke, A., Kühn, E., Kuras, T., Settele, J., et al. (2019). Protected areas do not mitigate biodiversity declines: A case study on butterflies. *Diversity and Distributions*, 25, 217–224.
- Ranasinghe, J. A., Stein, E. D., Miller, P. E., & Weisberg, S. B. (2012). Performance of two Southern California benthic community condition indices using species abundance and presence-only data: Relevance to DNA barcoding. *PLoS one*, 7, e40875.
- Ratnasingham, S., & Hebert, P. D. N. (2013). A DNA-based registry for all animal species: The barcode index number (BIN) system. *PLoS one*, 8, e66213.
- Richardson, R. T., Lin, C.-H., Quijia, J. O., Riusech, N. S., Goodell, K., & Johnson, R. M. (2015). Rank-based characterization of pollen assemblages collected by honey bees using a multilocus metabarcoding approach. *Applications in Plant Sciences*, 3, 1500043. doi:10.3732/apps.1500043.

- Richardson, S. M., Lintott, P. R., Hosken, D. J., Economou, T., & Mathews, F. (2021). Peaks in bat activity at turbines and the implications for mitigating the impact of wind energy developments on bats. *Scientific Reports*, *11*, 3636. doi:10.1038/s41598-021-82014-9.
- Ripple, W. J., Wolf, C., Newsome, T. M., Galetti, M., Alamgir, M., Crust, E., et al. (2017). World Scientists' Warning to Humanity: A Second Notice. *Bioscience*, *67*, 1026–1028.
- Rodner, E., Simon, M., Brehm, G., Pietsch, S., Wägele, J. W., & Denzler, J. (2015). Fine-grained recognition datasets for biodiversity analysis. *Computer Vision and Pattern Recognition Workshop on Fine-grained Visual Classification (CVPR-WS) 2015* 126–129 arXiv:1507.00913..
- Rodner, E., Freytag, A., Bodesheim, P., Fröhlich, B., & Denzler, J. (2017). Large-scale Gaussian Process Inference with generalized histogram intersection kernels for visual recognition tasks. *International Journal of Computer Vision (IJCV)*, *121*, 253–280.
- Roosjen, P. J., Kellenberger, B., Kooistra, L., Green, D. R., & Fahrentrapp, J. (2020). Deep learning for automated detection of *Drosophila suzukii*: Potential for UAV-based monitoring. *Pest Management Science*, *76*, 2994–3002.
- Royle, J. A., Chandler, R. B., Sollmann, R., & Gardner, B. (2013). *Spatial capture-recapture*. Academic Press.
- Ross, J. C., & Allen, P. E. (2014). Random forest for improved analysis efficiency in passive acoustic monitoring. *Ecological Informatics*, *21*, 34–39.
- Schindler, F., & Steinhage, V. (2021). Identification of animals and recognition of their actions in wildlife videos using deep learning techniques. *Ecological Informatics*, *61*, 101215. doi:10.1016/j.ecoinf.2021.101215.
- Schmidt, A. K. D., Riede, K., & Römer, H. (2011). High background noise shapes selective auditory filters in a tropical cricket. *The Journal of Experimental Biology*, *214*, 1754–1762.
- Schmidt, A. K. D., Römer, H., & Riede, K. (2012). Spectral niche segregation and community organization in a tropical cricket assemblage. *Behavioral Ecology*, *24*, 470–480. doi:10.1093/beheco/ars187.
- Scholes, R. J., Mace, G. M., Turner, W., Geller, G. N., Jürgens, N., Larigauderie, A., et al. (2008). Toward a global biodiversity observing system. *Science (New York, N.Y.)*, *321*, 1044–1045.
- Schuch, S., Bock, J., Krause, B., Wesche, K., & Schaefer, M. (2012). Long-term population trends in three grassland insect groups: A comparative analysis of 1951 and 2009. *Journal of Applied Entomology*, *136*, 321–331.
- Schulz, J., Möller, K. O., Bracher, A., Hieronymi, M., Cisewski, B., Zielinski, et al. (2015). Aquatische Optische Technologien in Deutschland. *Meereswissenschaftliche Berichte – Marine Scientific Reports, Warnemünde*, *97*, 1–83.
- Schulz, J. (2013). Geometric optics and strategies for subsea imaging. In Watson J. , & Zielinski O. (Eds.), *Subsea optics and imaging* (pp. 243–274). Woodhead Publishing Limited.
- Seibold, S., Gossner, M. M., Simons, N. K., Blüthgen, N., Müller, J., Ambarli, D., et al. (2019). Arthropod decline in grassland and forests is associated with landscape-level drivers. *Nature*, *574*, 671–674.
- Serrana, J. M., Miyake, Y., Gamboa, M., & Watanabe, K. (2019). Comparison of DNA metabarcoding and morphological identification for stream macroinvertebrate biodiversity assessment and monitoring. *Ecological Indicators*, *101*, 963–972.
- Seymour, M., Edwards, F. K., Cosby, B. J., Kelly, M. G., de Bruyn, M., & Carvalho, G. R. (2020). Executing multi-taxa eDNA ecological assessment via traditional metrics and interactive networks. *The Science of the Total Environment*, *729*, 138801. doi:10.1016/j.scitotenv.2020.138801.
- Smith, M. A., Woodley, N. E., Janzen, D. H., Hallwachs, W., & Hebert, P. D. N. (2006). DNA barcodes reveal cryptic host-specificity within the presumed polyphagous members of a genus of parasitoid flies (Diptera: Tachinidae). In *Proceedings of the National Academy of Sciences USA* (pp. 3657–3662).
- Sorg, M., Schwan, H., Stenmans, W., & Müller, A. (2013). Ermittlung der Biomassen flugaktiver Insekten im Naturschutzgebiet Orbroicher Bruch mit Malaise Fallen in den Jahren 1989 und 2013. *Mitteilungen des Entomologischen Vereins Krefeld*, *1*, 1–5.
- Ssymank, A., Sorg, M., Doczkal, D., Rulik, B., Merkel-Wallner, G., & Vischer-Leopold, M. (2018). Praktische Hinweise und Empfehlungen zur Anwendung von Malaise-fallen für Insekten in der Biodiversitätsforschung und im Monitoring. *Series Naturalis*, *1*, 1–12.
- Steenweg, R., Hebblewhite, M., Kays, R., Ahumada, J., Fisher, J. T., Burton, C., et al. (2017). Scaling-up camera traps: Monitoring the planet's biodiversity with networks of remote sensors. *Frontiers in Ecology and the Environment*, *15*, 26–34.
- Stepanian, P. M., Horton, K. G., Hille, D. C., Wainwright, C. E., Chilson, P. B., & Kelly, J. F. (2016). Extending bioacoustic monitoring of birds aloft through flight call localization with a three-dimensional microphone array. *Ecology and Evolution*, *6*, 7039–7046.
- Stepanian, P. M., Entrekina, S. A., Wainwright, C. E., Mirkovic, D., Tank, J. L., & Kelly, J. F. (2020). Declines in an abundant aquatic insect, the burrowing mayfly, across major North American waterways. *Proceedings of the National Academy of Science U.S.A.*, *117*, 2987–2992. doi:10.1073/pnas.1913598117.
- Suchan, T., Talavera, G., Sáez, L., Ronikier, M., & Vila, R. (2019). Pollen metabarcoding as a tool for tracking long-distance insect migrations. *Molecular Ecology Resources*, *19*, 149–162. doi:10.1111/1755-0998.12948.
- Sueur, J., Farina, A., Gasc, A., Pieretti, N., & Pavoine, S. (2014). Acoustic indices for biodiversity assessment and landscape investigation. *Acta Acustica United with Acustica*, *100*, 772–781.
- Sueur, J., Gasc, A., Grandcolas, P., & Pavoine, S. (2012). Global estimation of animal diversity using automatic acoustic sensors. In Le Gaillard J. F. , Guarini J. M. , Gaillif. (Eds.), *Sensors for ecology* (pp. 99–117). Paris: CNRS.
- Sueur, J., Pavoine, S., Hammerlynck, O., & Duvail, S. (2008). Rapid acoustic survey for biodiversity appraisal. *PloS one*, *3*, 1–9.
- Sugai, L. S. M. (2020). Pandemics and the need for automated systems for biodiversity monitoring. *The Journal of Wildlife Management*, *84*, 1424–1426. doi:10.1002/jwmg.21946.
- Sukopp, U. (2007). *Nachhaltigkeitsindikator für die artenvielfalt - ein Indikator für den zustand von natur und landschaft in deutschland*. Landwirtschaftsverlag.
- Szucsich, N. (2016). Austrian Barcode of Life – Qualität und Aktualität unseres Wissensstands zur Biodiversität in Österreich. *Natur und Landschaft*, *91*, 578–579.
- Tabak, M. A., Norouzzadeh, M. S., Wolfson, D. W., Sweeney, S. J., Vercauteren, K. C., Snow, N. P., et al. (2019). Machine learning to classify animal species in camera trap

- images: Applications in ecology. *Methods in Ecology and Evolution*, 10, 585–590. doi:10.1111/2041-210X.13120.
- Taberlet, P., Coissac, E., Hajibabei, M., & Rieseberg, L. H. (2012). Environmental DNA. *Molecular Ecology*, 21, 1789–1793.
- Takahara, T., Minamoto, T., Yamanaka, H., Doi, H., & Kawabata, Z. I. (2012). Estimation of fish biomass using environmental DNA. *PLoS one*, 7, e35868. doi:10.1371/journal.pone.0035868.
- Teickner, H., Lehmann, J. R., Guth, P., Meinking, F., & Ott, D. (2019). Recognize the little ones: UAS-based in-situ fluorescent tracer detection. *Drones*, 3, 20.
- Tholl, D., Boland, W., Hansel, A., Loreto, F., Röse, U. S. R., & Schnitzler, J.-P. (2006). Practical approaches to plant volatile analysis. *The Plant Journal*, 45, 540–560.
- Thomsen, P. F., Kielgast, J., Iversen, L. L., Wiuf, C., Rasmussen, M., & Gilbert, M. T. (2011). Monitoring endangered freshwater biodiversity using environmental DNA. *Molecular Ecology*, 21, 2565–2573. doi:10.1111/j.1365-1294X.2011.05418.x.
- Towsey, M., Planitz, B., Nantes, A., Wimmer, J., & Roe, P. (2012). A toolbox for animal call recognition. *Bioacoustics*, 21, 107–125.
- Towsey, M., Zhang, L., Cottman-Fields, M., Wimmer, J., & Roe, P. (2014). Visualization of longduration acoustic recordings of the environment. *Procedia Computer Science*, 29, 703–712.
- Tucker, D., Gage, S. H., Williamson, I., & Fuller, S. (2014). Linking ecological condition and the soundscape in fragmented Australian forests. *Landscape Ecology*, 29, 745–758.
- Tuovinen, K., Paakkanen, H., & Hänninen, O. (2000). Detection of pesticides from liquid matrices by ion mobility spectrometry. *Analytica Chimica Acta*, 404, 7–17.
- UNEP (2003). *Convention on the Conservation of Migratory Species of Wild Animals (CMS)*. <http://www.cms.int/en/node/3916>. Accessed October 7, 2014.
- UNEP. (2012). Global Environment Outlook 5: Environment for the future we want. *United Nations Environment Programme*. <http://www.unep.org/geo/geo5.asp> Accessed March 2014.
- Valentin, i A., Miquel, C., Nawaz, M. A., Bellemain, E., Coissac, E., Pompanon, F., et al. (2009). New perspectives in diet analysis based on DNA barcoding and parallel pyrosequencing: The trnL approach. *Molecular Ecology Resources*, 9, 51–60.
- Van Berkel, T. (2014). *Camera trapping. expedition field techniques for wildlife conservation*. London: Royal Geographical Society.
- Van Dyck, H., Van Strien, A. J., Maes, D., & Van Swaay, C. A. (2009). Declines in common, widespread butterflies in a landscape under intense human use. *Conservation Biology*, 23, 957–965.
- Van Horn, G., & Perona, P. (2017). The devil is in the tails: Fine-grained classification in the wild. <https://arxiv.org/abs/1709.01450>.
- Van Strien, A. J., van Swaay, C. A. M., van Strien-van Liempe, W. T. F. H., Poot, M. J. M., & Wallis De Vries, M. F. (2019). Over a century of data reveal more than 80% decline in Butterflies in the Netherlands. *Biological Conservation*, 234, 116–122.
- Van Swaay, C., Van Strien, A., Harpke, A., Fontaine, B., Stefanescu, C., Roy, D., et al. (2013). The European grassland butterfly indicator: 1990–2011. *European Environmental Agency Technical Report*, 11/20131–36. doi:10.2800/89760 <https://doi.org/10.2800/89760>
- Vautz, W., Nolte, J., Fobbe, R., & Baumbach, J. I. (2009). Breath analysis - performance and potential of ion mobility spectrometry. *Journal of Breath Research*, 3, 036004. doi:10.1088/1752-7155/3/3/036004.
- Vautz, W., Slodzynski, R., Hariharan, C., Seifert, L., Nolte, J., Fobbe, R., et al. (2013). Detection of Metabolites of Trapped Humans using Ion Mobility Spectrometry Coupled to Gas-Chromatography. *Analytical Chemistry*, 85, 2135–2142.
- Vautz, W., Baumbach, J. I., & Jung, J. (2006). Beer fermentation control using ion mobility spectrometry. *Journal of the Institute of Brewing*, 112, 157–164.
- Vautz, W., Hariharan, C., & Weigend, M. (2018). Smell the change: On the potential of gas-chromatographic ion mobility spectrometry in ecosystem monitoring. *Ecology and Evolution*, 8, 4370–4377.
- Vereecken, N. J., Weekers, T., Leclercq, N., De Greef, S., Hainaut, H., & Molenberg, J. M. (2021). Insect biomass is not a consistent proxy for biodiversity metrics in wild bees. *Ecological Indicators*, 121, 107132. doi:10.1016/j.ecolind.2020.107132.
- Vogel, G. (2017). Where have all the insects gone? *Science (New York, N.Y.)*, 356, 576–579.
- Wagner, D. L. (2020). Insect declines in the Anthropocene. *Annual Review of Entomology*, 65, 457–480.
- Wäldchen, J., & Mäder, P. (2018). Machine learning for image based species identification. *Methods in Ecology and Evolution*, 9, 2216–2225. doi:10.1111/2041-210X.13075.
- Wäldchen, J., & Mäder, P. (2019). Flora Incognita – wie künstliche Intelligenz die Pflanzenbestimmung revolutioniert. *Biologie in unserer Zeit*, 49, 99–101. doi:10.1002/biuz.201970211.
- White, P. J., Glover, K., Stewart, J., & Rice, A. (2016). The technical and performance characteristics of a low-cost, simply constructed, black light moth trap. *Journal of insect science*, 16, 25. doi:10.1093/jisesa/iew011.
- Wilkinson, M., Dumontier, M., Aalbersberg, I., Appleton, G., Axton, M., Baak, A., et al. (2016). The FAIR Guiding Principles for scientific data management and stewardship. *Scientific Data*, 3, 160018. doi:10.1038/sdata.2016.18.
- Willmott, J. R., Forcey, G. M., & Hooton, L. A. (2015). Developing an automated risk management tool to minimize bird and bat mortality at wind facilities. *Ambio*, 44, 557–571.
- Woodcock, B. A., Isaac, N. J. N., Bullock, J. M., Roy, D. B., Garthwaite, D. G., Crowe, A., et al. (2016). Impacts of neonicotinoid use on long-term population changes in wild bees in England. *Nature Communications*, 7. doi:10.1038/ncomms12459 article 12459.
- Wührl, L., Pylatiuk, C., Giersch, M., Lapp, F., von Rintelen, T., Balke, M., et al. (2021). DiversityScanner: Robotic discovery of small invertebrates with machine learning methods. *bioRxiv – Zoology*, 2021-05-18. doi:10.1101/2021.05.17.444523.
- WWF. (2016). *Living Planet Report 2016. Risk and resilience in a new era* WWW International, Gland, Switzerland.
- Yang, H., Wu, H., & Chen, H. (2019). Detecting 11K classes: Large scale object detection without fine-grained bounding boxes. In *Proceedings of the IEEE/CVF International Conference on Computer Vision (ICCV)* (pp. 9804–9812). doi:10.1109/ICCV.2019.00990.

- Yao, Q., Liu, Q., Dieterich, T. G., Todorovic, S., Lin, J., Diao, G., et al. (2013). Segmentation of touching insects based on optical flow and NCuts. *Biosystems Engineering*, *114*, 67–77.
- Yu, D. W., Ji, Y., Emerson, B. C., Wang, X., Ye, C., Yang, C., et al. (2012). Biodiversity soup: Metabarcoding of arthropods for rapid biodiversity assessment and biomonitoring. *Methods in Ecology and Evolution*, *3*, 613–623. doi:10.1111/j.2041-210X.2012.00198.x.
- Yu, D. W., Ji, Y., Emerson, B. C., Wang, X., Ye, C., Yang, C., et al. (2012). Biodiversity soup: Metabarcoding of arthropods for rapid biodiversity assessment and biomonitoring. *Methods in Ecology and Evolution*, *3*, 613–623.
- Zenker, M. M., Rougerie, R., Teston, J. A., Laguerre, M., Pie, M. R., & Freitas, A. V. (2016). Fast census of moth diversity in the Neotropics: A comparison of field-assigned morpho-species and DNA barcoding in tiger moths. *PloS one*, *11*, e0148423. doi:10.1371/journal.pone.0148423.
- Zenker, M. M., Specht, A., & Fonseca, V. G. (2020). Assessing insect biodiversity with automatic light traps in Brazil: Pearls and pitfalls of metabarcoding samples in preservative ethanol. *Ecology and Evolution*, *10*, 2352–2366. doi:10.1002/ece3.6042.
- Zhang, P. O., Sadler, C. M., Lyon, S. A., & Martonosi, M. (2004). Hardware design experiences in ZebraNet. In *Proceedings of the 2nd International Conference on Embedded Networked Sensor Systems, SenSys'04* (pp. 227–238). doi:10.1145/1031495.1031522.
- Zhong, Y., Gao, J., Lei, Q., & Zhou, Y. (2018). A vision-based counting and recognition system for flying insects in intelligent agriculture. *Sensors*, *18*, 1489. doi:10.3390/s18051489.
- Zhou, X., Li, Y., Liu, S., Yang, Q., Su, X., Zhou, L., et al. (2013). Ultra-deep sequencing enables high-fidelity recovery of biodiversity for bulk arthropod samples without PCR amplification. *GigaScience*, *2*, 1–12.
- Zimmermann, J., Glöckner, G., Jahn, R., Enke, N., & Gemeinholzer, B. (2014). Metabarcoding vs. morphological identification to assess diatom diversity in environmental studies. *Molecular Ecology Resources*, *15*, 526–542.

Available online at www.sciencedirect.com

ScienceDirect